

DVD Player/ Recorder

DVDR3305

User Manual

Thank you for choosing Philips.

Need help fast?

Read your Quick Use/Start Guide and/or User Manual first for quick tips that make using your Philips product more enjoyable.

If you have read your instructions and still need assistance, you may access our online help at www.philips.com/support



VIDEO *Plus+*®

PHILIPS

Important notes for users in the U.K. Mains plug

This apparatus is fitted with an approved 13 Amp plug. To change a fuse in this type of plug proceed as follows:

- 1 Remove fuse cover and fuse.
- 2 Fix new fuse which should be a BSI 362 5 Amp, A.S.T.A. or BSI approved type.
- 3 Refit the fuse cover.

If the fitted plug is not suitable for your socket outlets, it should be cut off and an appropriate plug fitted in its place.

If the mains plug contains a fuse, this should have a value of 5 Amp. If a plug without a fuse is used, the fuse at the distribution board should not be greater than 5 Amp.

Note: The severed plug must be disposed of to avoid a possible shock hazard should it be inserted into a 13 Amp socket elsewhere.

How to connect a plug

The wires in the mains lead are coloured with the following code: blue = neutral (N), brown = live (L).

As these colours may not correspond with the colour markings identifying the terminals in your plug, proceed as follows:

- Connect the blue wire to the terminal marked N or coloured black.
- Connect the brown wire to the terminal marked L or coloured red.
- Do not connect either wire to the earth terminal in the plug, marked E (or e) or coloured green (or green and yellow).

Before replacing the plug cover, make certain that the cord grip is clamped over the sheath of the lead - not simply over the two wires.

Copyright in the U.K.

Recording and playback of material may require consent. See Copyright Act 1956 and The Performer's Protection Acts 1958 to 1972.

Italia DICHIARAZIONE DI CONFORMITA'

Si dichiara che l'apparecchio DVDR3305, Philips risponde alle prescrizioni dell'art. 2 comma 1 del D.M. 28 Agosto 1995 n. 548.

Fatto a Eindhoven

Philips Consumer Electronics
Philips, Glaslaan 2
5616 JB Eindhoven, The Netherlands

Norge

Typeskilt finnes på apparatens underside.

Observer: Nettbryteren er sekundert innkopleet. Den innebygde nettdelen er derfor ikke frakopleet nettet så lenge apparatet er tilsluttet nettkontakten.

For å redusere faren for brann eller elektrisk støt, skal apparatet ikke utsettes for regn eller fuktighet.

For Customer Use:

Read carefully the information located at the bottom or rear of your DVD Recorder and enter below the Serial No. Retain this information for future reference.

Model No. DVD RECORDER
 DVDR3305

Serial No. _____

DK

Advarsel: Usynlig laserstråling ved åbning når sikkerhedsafbrydere er ude af funktion. Undgå udsættelse for stråling.

Bemærk: Netafbryderen er sekundært indkoblet og afbryder ikke strømmen fra nettet. Den indbyggede netdel er derfor tilsluttet til lysnettet så længe netstikket sidder i stikkontakten.

S

Klass I laserapparat

Varning! Om apparaten används på annat sätt än i denna bruksanvisning specificerats, kan användaren utsättas för osynlig laserstrålning, som överskrider gränsen för laserklass I.

Observera! Stömbrytaren är sekundärt kopplad och bryter inte strömmen från nätet. Den inbyggda nät delen är därför ansluten till elnätet så länge stickproppen sitter i vägguttaget.

SF

Luokan I laserlaite

Varoitus! Laitteen käyttäminen muulla kuin tässä käyttöohjeessa mainitulla tavalla saattaa altistaa käyttäjän turvallisuusluokan I ylittävälle näkymättömälle lasersäteilylle.

Oikeus muutoksiin varataan. Laite ei saa olla alttiina tippu- ja roiskevedelle.

Huom. Toiminnanvalitsin on kytketty toisiopuolelle, eikä se kytke laitetta irti sähköverkosta. Sisäänrakennettu verkko-osa on kytkettynä sähköverkkoon aina silloin, kun pistoke on pistorasiassa.

Copyright notice

"The making of unauthorized copies of copy-protected material, including computer programmes, files, broadcasts and sound recordings, may be an infringement of copyrights and constitute a criminal offence. This equipment should not be used for such purposes."

CAUTION

VISIBLE AND INVISIBLE LASER RADIATION
WHEN OPEN AVOID EXPOSURE TO BEAM
ADVARSEL

SYNLIG OG USYNLIG LASERSTRÅLING VED
ÅBNING UNDGÅ UDSÆTTELSE FOR
STRÅLING

VARNING

SYNLIG OCH OSYNLIG LASERSTRÅLNING
NÄR DENNA DEL ÄR ÖPPNAD BETRAKTA
EJ STRÅLEN

VARO!

AVATTAESSA OLET ALTTIINA NÄKYVÄLLE
JA NÄKYMÄTTÖMÄLLE LASER SÄTEILYLLE.
ÄLÄ KATSO SÄTEESEEN

VORSICHT

SICHTBARE UND UNSICHTBARE
LASERSTRAHLUNG WENN ABDECKUNG
GEÖFFNET NICHT DEM STRAHL
AUSSETZEN

ATTENTION

RAYONNEMENT LASER VISIBLE ET
INVISIBLE EN CAS D'OUVERTURE
EXPOSITION DANGEREUSE AU FAISCEAU

Disposal of your old product



Your product is designed and manufactured with high quality materials and components, which can be recycled and reused.

When this crossed-out wheeled bin symbol is attached to a product it means the product is covered by the European Directive 2002/96/EC. Please inform yourself about the local separate collection system for electrical and electronic products.

Please act according to your local rules and do not dispose of your old products with your normal household waste. The correct disposal of your old product will help prevent potential negative consequences for the environment and human health.

Disposal of your old product



Your product is designed and manufactured with high quality materials and components, which can be recycled and reused.

When this crossed-out wheeled bin symbol is attached to a product it means the product is covered by the European Directive 2002/96/EC.

Please inform yourself about the local separate collection system for electrical and electronic products.

Please act according to your local rules and do not dispose of your old products with your normal household waste. The correct disposal of your old product will help prevent potential negative consequences for the environment and human health.

Index

English7

English

This product complies with the radio interference requirements of the European Community.



This product complies with the requirements of the following directives and guidelines: 73/23/EEC + 89/336/EEC + 93/68/EEC

LASER

Type	Semiconductor laser InGaAlP (DVD) AlGaAs (CD)
Wave length	658 nm (DVD) 790 nm (CD)
Output Power	30 mW (DVD±RW write) 1.0 mW (DVD read) 1.0 mW (CD read)
Beam divergence	84 degrees (DVD) 61 degrees (CD)



Manufactured under license from Dolby Laboratories. "Dolby" and the double-D symbol are trademarks of Dolby Laboratories.



This product incorporates copyright protection technology that is protected by US patents and other intellectual property rights. Use of this copyright protection technology must be authorized by Macrovision, and is intended for home and other limited viewing uses only unless otherwise authorized by Macrovision. Reverse engineering or disassembly is prohibited.

U.S. Patent Numbers 4,631,603; 4,819,098; 4,907,093; 5,315,448 and 6,516,132.



This is a simple programming system for DVD recorders. To use it, enter the programming number associated with your television programme. You can find this number in your favourite listings magazine.

VIDEO Plus+® is a registered trademark of Gemstar Development Corporation. VIDEO Plus+® is manufactured under license from Gemstar Development Corporation.

Frequently Asked Questions

What kind of disc should I use for recording?

You can only record on DVD±R and DVD±RW discs. DVD±R/±RW is the most compatible recordable DVD format on the market today. They are fully compatible to most of the existing DVD-Video players and DVD-ROM drives in computers.

What is the capacity of a DVD±R/±RW disc?

4.7GB, or equivalent to 6 CDs. You can store only one hour of recordings on a single disc at the highest quality (DVD standard) and about 6 hours recordings at the lowest quality (VHS standard).

The recording mode indicates the number of hours that will fit on a single disc.

What is the difference between DVDvR and DVD±RW?

DVD±R is “recordable” and DVD±RW is “erasable” and “rewritable”. With a DVD±R, you can record multiple sessions on the same disc, but when the disc is full, you cannot record any more on the disc. The DVD±RW allows you to record over the same disc repeatedly.

Can I copy a VHS tape or DVD from an external player?

Yes, but only if the VHS tape or DVD is not copy protected.

What are Titles and Chapters?

A DVD disc contains Titles and Chapters, which are similar to the Titles and Chapters of a book. A Title is often a complete movie and is broken down into Chapters, or individual scenes from the movies.

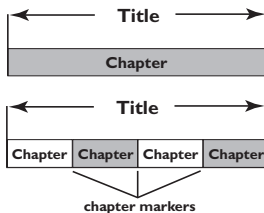

Programmes are recorded as a single title, it may consist of one chapter or a few chapters within a title, depending on the recording settings.

How do I set up Titles and Chapters?

The DVD recorder automatically creates a new Title every time you start a new recording. You can then add Chapters to these recordings manually or have them automatically inserted at 5-minutes intervals.

What does “finalising” a disc do?

Finalising a disc locks the disc so it can no longer be recorded, only required for DVD±R. It will then be compatible with virtually any DVD player. To close a disc without finalising it, simply stop recording and eject the disc. You will still be able to record on the disc if there is storage space for more recordings.

How good is the quality of the recording?

There are a few picture quality levels to choose from, ranging from “1 hour mode” (High Quality) to “6 hours mode” (VHS quality). Press REC MODE button on the remote control to choose the quality level that best suits your purpose and the length of material.

Maximum Recording Time per Disc	Picture Quality	Record Mode
1 hour	High quality	1 Hour Mode
2 hours	DVD quality-Standard Play	2 Hour Mode
4 hours	VHS quality-Extended Play	4 Hour Mode
6 hours	VHS quality-Super Long Play	6 Hour Mode

Contents

Frequently Asked Questions 7

Care and Safety Information

Setup precautions.....	10
Cleaning discs	10
About recycling	10

General Information..... 11

Introduction	11
Accessories supplied.....	11
Region codes.....	11
Copyright notice	11

Basic Connections - DVD recorder

Step 1: Connecting the antenna cables	12
Step 2: Connecting the video cable.....	13
Option 1: Using a Scart cable	13
Option 2: Using an S-Video cable	13
Option 3: Using a Video (CVBS) cable..	13
Step 3: Connecting the audio cables ...	14
Option 1: Using an audio cable	14
Option 2: Using a coaxial cable	14

Optional Connections

Connecting to a Cable Box or Satellite Receiver	15
Connecting to a VCR or other similar device	16
Connecting to a VCR and Cable Box/ Satellite Receiver	17
Connecting a camcorder to the front sockets	18
Using S-VIDEO In or VIDEO In socket.	18

Main Unit..... 19

Sockets behind the flap	19
-------------------------------	----

Remote Control 20~21

Getting Started

Step 1: Inserting Batteries.....	22
Using the remote control to operate the system.....	22
Step 2: Finding the viewing channel....	22
Step 3: Select the country of your residence.....	23
Step 4: TV channel programming.....	23
Automatic TV channel search	23
Modifying Channel Information	24
Sorting the TV channels.....	25
Step 5: Setting the language.....	25
Step 6: Setting the time & date.....	26

Recording

Discs for recording.....	27
Recording settings	27
Auto Chapter Markers.....	28
Default Source.....	28
Default Recording Mode.....	28
Manual recording.....	29
One Touch Recording - automatic turn-off	29
About timer recording.....	30
Timer recording (manually)	30
Setting a timer recording from an external Cable Box/Satellite Receiver...31	
Timer recording (VIDEO Plus+® System)	32
Changing/Deleting a timer recording.	33
Simultaneous recording and playback	33

Editing/Finalising Recording

About disc editing.....	34
Accessing disc editing menu.....	34
Rename disc.....	35
Erase disc (DVD±RW only).....	35
Record new title.....	35
Overwrite disc (DVD±RW only).....	35
Make compatible (DVD±RW only)	36
Lock/Unlock disc (DVD±RW only)	36
Playing your recordings (DVD±R) on other DVD players	36

Contents

About title editing	37
Accessing title editing menu	37
Video editing	37
Rename title	38
Erase title	38
Overwrite title (DVD±RW only)	38
Overwrite from the selected title	38
Append recording	38
About video editing.....	39
Accessing video editing menu	39
Selecting a title.....	40
Selecting a chapter.....	40
Creating chapter marker	40
Hiding an unwanted chapter.....	41
Changing Index Picture	41
Splitting a title (DVD±RW only).....	41

Playback

Playable discs.....	42
Inserting a disc.....	42
Starting disc playback	43
Playing a DVD video disc	43
Playing a (Super) Video CD.....	43
Playing an audio CD	43
Playing a DVD±R/±RW disc.....	44
Playing a MP3 disc	44
Playing a picture disc (or musical slide show)	45

Additional Playback Features

Changing to another title/chapter/ track	46
Pausing playback and step play	46
Searching forwards/backwards.....	46
Using T/C options	47
Selecting various repeat/shuffle functions	47
Programming disc tracks.....	48
Changing the audio soundtrack language	48
Changing subtitle language	49
Switching camera angles.....	49
Time search	49

DVD System Menu Options

Accessing System Menu - General	50
Screen Saver	50
Country	50
Video Output Format.....	51
Restore Factory settings.....	51
Accessing System Menu -Playback	52
TV Aspect Ratio	52
Parental rating level.....	53
Setting or changing the password	54
Digital Audio Output.....	54
Accessing System Menu - Record	55
Accessing System Menu - Language.....	55
Accessing System Menu - Channel Setup	55
Accessing System Menu - Clock.....	55
Date and Time	55

Troubleshooting 56~57

Specifications..... 58

Glossary..... 59

Care and Safety Information

CAUTION!

High voltage! Do not open the device. You run the risk of getting an electric shock.

The machine does not contain any user-serviceable parts. Please leave all maintenance work to qualified personnel.

Setup precautions

Finding a suitable location

- Place the set on a flat, hard and stable surface. Do not place the set on a carpet.
- Do not position the set on top of other equipment that might heat it up (e.g., receiver or amplifier).
- Do not put anything under or above the set (e.g., CDs, magazines).
- Install the unit near the AC outlet and where the AC power plug can be reached easily.

Space for ventilation

- Place the apparatus in a location with adequate ventilation to prevent internal heat build up. Allow at least 10 cm (4.5") clearance from the rear and the top of the set and 5 cm (2.3") from the left and right to prevent overheating.

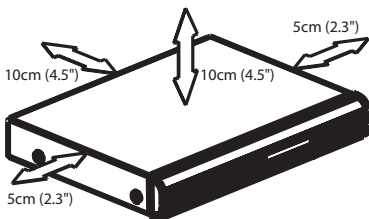

Avoid high temperatures, moisture, water and dust

- Apparatus shall not be exposed to dripping or splashing.
- Do not place any sources of danger on the apparatus (e.g., liquid filled objects, lighted candles).

Cleaning discs

Some problems occur because the disc inside the recorder is dirty (frozen picture, sound disruptions, picture distortions). To avoid these problems, discs should be cleaned on a regular basis.

To clean a disc, use a micro fibre cleaning cloth and wipe the disc from the center to the edge in a straight line.

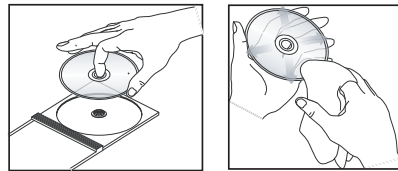

CAUTION!

Do not use solvents such as benzene, thinner, commercially available cleaners, or anti-static sprays intended for analogue discs.

Since the optical unit (laser) of the DVD recorder operates at a higher power than regular DVD or CD players, cleaning CDs intended for DVD or CD players may damage the optical unit (laser). Therefore, refrain from using a cleaning CD.

About recycling

These operating instructions have been printed on non-polluting paper. This electronic equipment contains a large number of materials that can be recycled. If you are disposing of an old machine, please take it to a recycling center. Please observe the local regulations regarding disposal of packaging materials, exhausted batteries, and old equipment.

General Information

Introduction

Your Philips DVD recorder allows you to record the TV programmes or duplicate camcorder recordings to a DVD±RW or DVD±R and play pre-recorded DVDs. The recordings you make on the recorder will play on most of the DVD players and DVD-ROM drives. The DVD±R discs have to be finalised before they can be played on other DVD players.

Please take time to read this user manual before using your DVD recorder. It contains important information and notes regarding operations of this recorder.

Helpful Hints:

- *If you have questions or if problems come up during operation, please see the chapter 'Troubleshooting'.*
- *If you need further assistance, please call the customer support service for your country. The corresponding telephone numbers and e-mail addresses are given in the guarantee booklet.*
- *Refer to the type plate on the rear or bottom of the product for identification and supply ratings.*

Accessories supplied

- Remote control and batteries
- Scart cable
- RF coaxial cable
- Quick Use Guide
- User Manual

Region codes

DVD films are usually not released at the same time in all regions of the world, thus all DVD players are keyed to a specific region code.

This device will only play **Region 2** DVDs or DVDs manufactured to be played in all regions 'ALL'. DVDs from other regions cannot be played on this DVD recorder.



Copyright notice

The making of unauthorized copies of copy-protected material, including computer programmes, files, broadcasts and sound recordings, may be an infringement of copyrights and constitute a criminal offence. This equipment should not be used for such purposes.

Basic Connections - DVD recorder

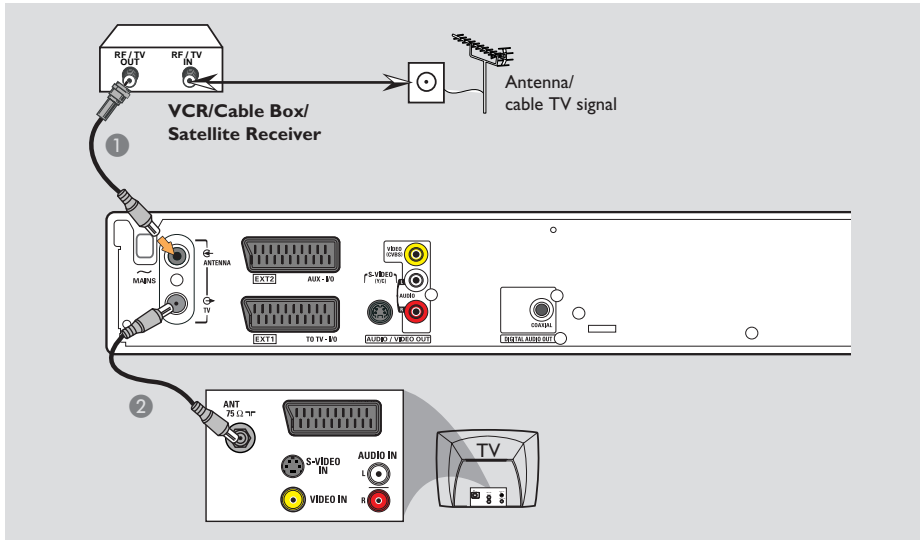

Step 1: Connecting the antenna cables

These connections enable you to watch and record TV programmes using the DVD recorder. If the antenna signal is connected via a VCR, Cable Box or Satellite Receiver, ensure that these devices are turned on in order to watch or record the cable programmes.

- **If you want to connect to a VCR and/or Cable Box/ Satellite Receiver**, see page 15 ~17 for the complete connection to your TV.

- 1 Connect the existing Antenna/ Cable TV signal (or from the Cable Box/ Satellite Receiver {RF OUT or TO TV}) to the **ANTENNA** socket on the DVD recorder.
- 2 Use the supplied RF coaxial cable to connect the **TV** socket on the DVD recorder to the antenna input socket on your TV (VHF/ UHF RF IN).

TIPS: Before making or changing any connections, make sure that all the devices are disconnected from the power outlet.

Basic Connections - DVD recorder (continued)

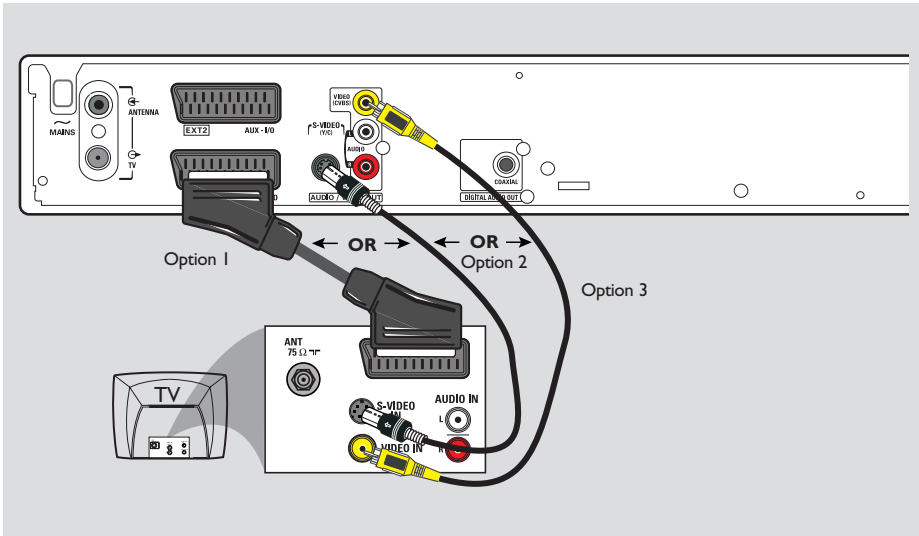

Step 2: Connecting the video cable

This connection enables you to view the disc playback from the DVD recorder. You only need to choose **one** of the options below to make your video connection.

Option 1: Using a Scart cable (best picture quality)

- Use the scart cable to connect the **EXT1 TO TV-I/O** socket on the DVD recorder to the corresponding SCART input socket on the TV.

Helpful Hints:

- If your TV set has several SCART sockets, select the SCART socket that is suitable for both video *output* and video *input*.
- If your TV set displays a selection for the SCART socket, select 'VCR' as the source for the SCART socket.
- The EXT2 AUX-I/O socket is intended only for additional devices.

TIPS: Before making or changing any connections, make sure that all the devices are disconnected from the power outlet.

Option 2: Using an S-Video cable (excellent picture quality)

- Use a S-video cable (not supplied) to connect the **S-VIDEO (Y/C)** socket on the DVD recorder to the S-Video input socket (possibly labelled as Y/C or S-VHS) on the TV.

Option 3: Using a Video (CVBS) cable (good picture quality)

- Use a composite video cable (yellow - not supplied) to connect the **VIDEO (CVBS)** socket on the DVD recorder to the video input socket (possibly labelled as A/V In, Video In, Composite or Baseband) on the TV.

Basic Connections - DVD recorder (continued)

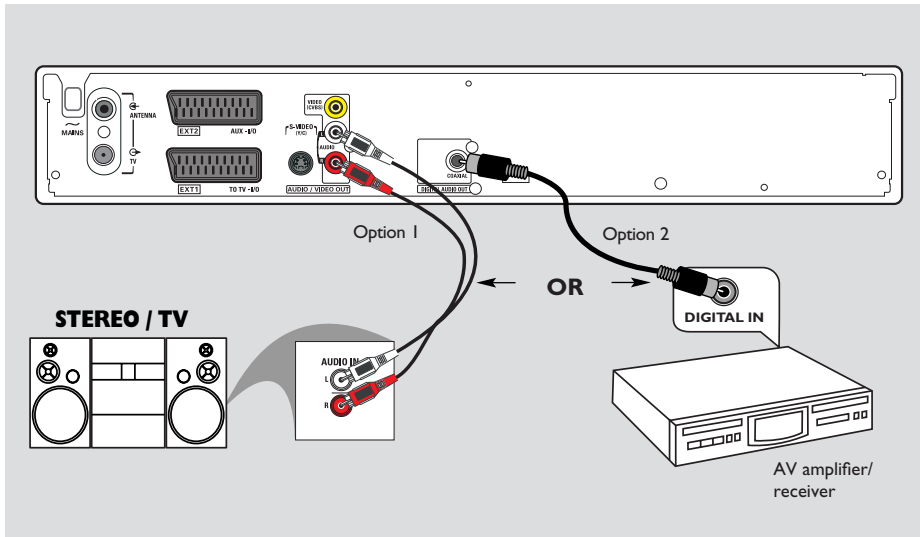

Step 3: Connecting the audio cables

This connection enables you to listen to the sound. This connection is not required if the DVD recorder is connected to the TV using the scart cable.

Option 1: Using an audio cable

You can connect the DVD recorder to a two channel stereo system or receiver in order to enjoy the stereo sound system.

- Use an audio cables (red/white ends - not supplied) to connect the **AUDIO L/R** sockets to one of the following devices with the same input sockets.
 - a stereo system (for example, TV or mini system).
 - a receiver with two channel analogue stereo.

Option 2: Using a coaxial cable

You can connect the DVD recorder to an AV amplifier/receiver with a digital multichannel sound decoder in order to enjoy multichannel surround sound.

- Use a coaxial cable (not supplied). Connect the recorder to the receiver/ amplifier from the coaxial jack of the recorder to the digital input of the receiver.

Before you start operating, set the Digital Audio Output accordingly (see page 54). If the Digital Output setting does not match your stereo's capabilities, the stereo may produce a strong, distorted sound or no sound at all.

TIPS: Before making or changing any connections, make sure that all the devices are disconnected from the power outlet.

Optional Connections

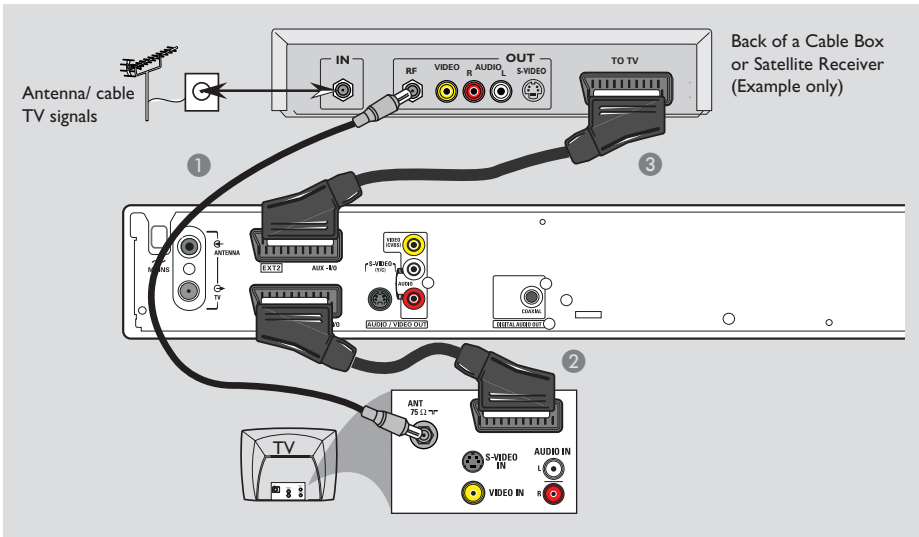

English

Connecting to a Cable Box or Satellite Receiver

Option 1

If your Cable Box/ Satellite Receiver has only an antenna output socket (RF OUT or TO TV), refer to “Connecting the antenna cables” on page 12 for the complete connection to your TV.

Option 2

If your Cable Box/ Satellite Receiver has a scart output socket

- 1 Keep the existing antenna connection from the Cable Box/ Satellite Receiver to your TV.
- 2 Use the scart cable to connect the **EXT1 TO TV-I/O** socket on the DVD recorder to the corresponding SCART input socket on the TV.
- 3 Use another scart cable to connect the **EXT2 AUX-I/O** socket on the DVD recorder to the scart output socket (possibly labelled as TV OUT or TO TV) on the Cable Box/ Satellite Receiver.

To start playback, select the TV channel directly on the Cable Box/ Satellite Receiver. The DVD recorder will automatically send the video/ audio signals from the **EXT2 AUX-I/O** socket to **EXT1 (TO TV-I/O)** socket. You will then see the picture from the additional device on your TV, even if the DVD recorder is turned off.

TIPS: Before making or changing any connections, make sure that all the devices are disconnected from the power outlet.

Optional Connections (continued)

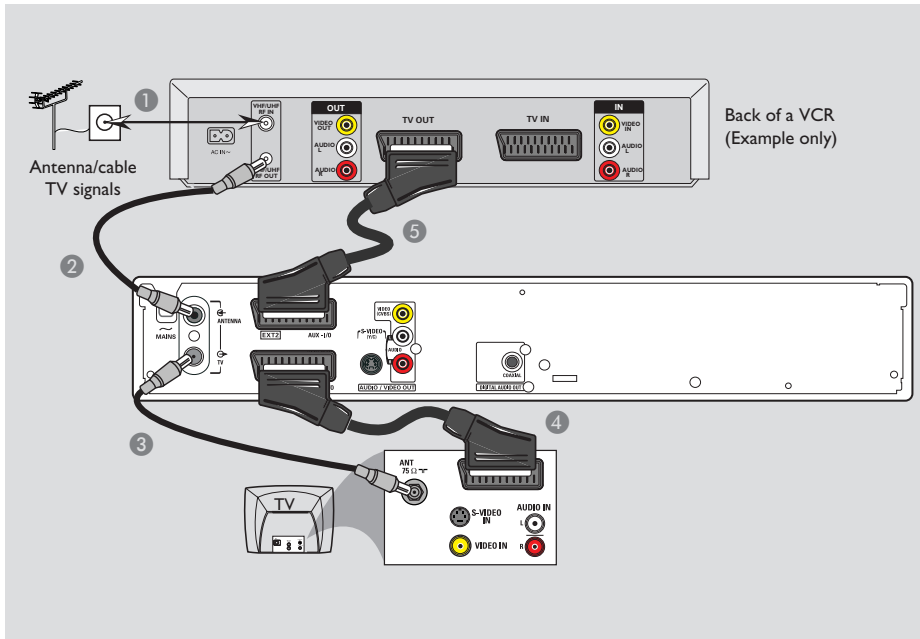

Connecting to a VCR or other similar device

This connection enables you to record from video tape to a DVD±R/±RW and allows the VCR to be used for playback if the DVD recorder is turned off.

- 1 Connect the Antenna/ Cable TV signal to the antenna input (RF IN) socket on the VCR.
- 2 Use the supplied RF coaxial cable to connect the antenna output (RF OUT) socket on the VCR to the **ANTENNA** socket on the DVD recorder.
- 3 Use another RF coaxial cable to connect the **TV** socket on the DVD recorder to the antenna input socket on the TV.

- 4 Use the scart cable to connect the **EXT1 TO TV-I/O** socket on the DVD recorder to the corresponding SCART input socket on the TV.
- 5 Use another scart cable to connect the **EXT2 AUX-I/O** socket on the DVD recorder to the scart output socket (possibly labelled as TV OUT or TO TV) on the VCR.

Helpful Hints:

- Most commercial video cassettes and DVDs are copy-protected and therefore cannot be recorded.
- Connect the DVD recorder directly to the TV. If there is a VCR or an additional device in between, the picture quality may be poor because of the copy protection system built into the DVD recorder.

TIPS: Before making or changing any connections, make sure that all the devices are disconnected from the power outlet.

Optional Connections (continued)

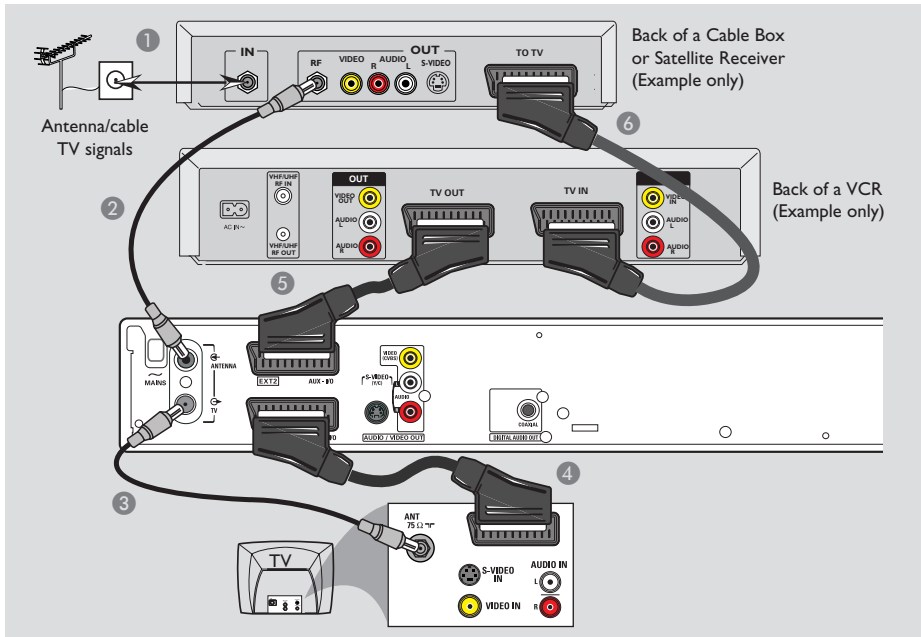

English

Connecting to a VCR and Cable Box/ Satellite Receiver

- 1 Connect the Antenna/ Cable TV signal to the antenna input (RF IN) socket on the Cable Box/ Satellite Receiver.
- 2 Use the supplied RF coaxial cable to connect the antenna output (RF OUT) socket on the Cable Box/ Satellite Receiver to the **ANTENNA** socket on the DVD recorder.
- 3 Use another RF coaxial cable to connect the **TV** socket on the DVD recorder to the antenna input socket on the TV.
- 4 Use the scart cable to connect the **EXT1 TO TV-I/O** socket on the DVD recorder to the corresponding SCART input socket on the TV.
- 5 Use another scart cable to connect the **EXT2 AUX-I/O** socket on the DVD recorder to the scart output socket (possibly labelled as TV OUT or TO TV) on the VCR.
- 6 Use another scart cable to connect the scart input (TV IN) socket on the VCR to the scart output socket (possibly labelled as TV OUT or TO TV) on the Cable Box/Satellite Receiver.

TIPS: Before making or changing any connections, make sure that all the devices are disconnected from the power outlet.

Optional Connections (continued)

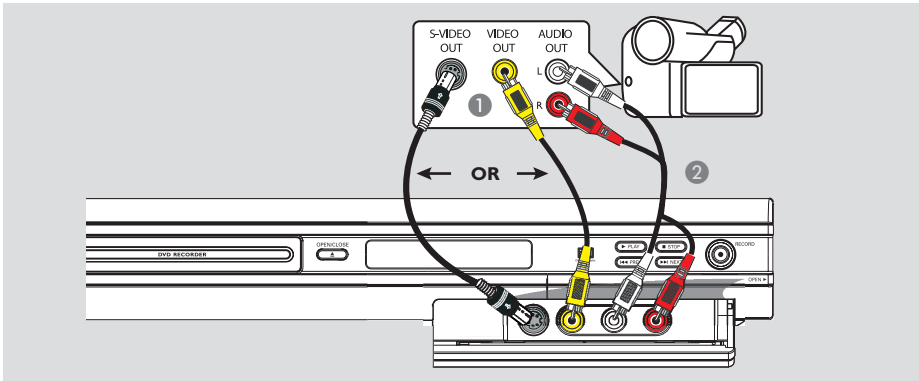

Connecting a camcorder to the front sockets

You can use the front sockets to copy camcorder recordings. These sockets are located behind the flap on the right hand side and provides convenient connections for a camcorder.

Before you start operating, press **REC SOURCE** on the remote control repeatedly to select 'Front S-VIDEO' or 'Front CVBS' as the input channel, depending on your connections. For recording, see pages 27~29.

Using S-VIDEO In or VIDEO In socket

Use the S-VIDEO connection if you have a Hi8 or S-VHS(C) camcorder. It provides better picture quality.

Alternatively, you can use VIDEO connection if your camcorder has only a single video output (Composite Video, CVBS).



- 1 Connect the **S-VIDEO** or **VIDEO** socket at the front panel of the DVD recorder to the corresponding S-VHS or Video output socket on the camcorder.
- 2 Use an audio cable (red/ white ends) to connect the **AUDIO L/R** sockets at the front panel of the DVD recorder to the audio output sockets on the camcorder.

TIPS: Before making or changing any connections, make sure that all the devices are disconnected from the power outlet.

Main Unit

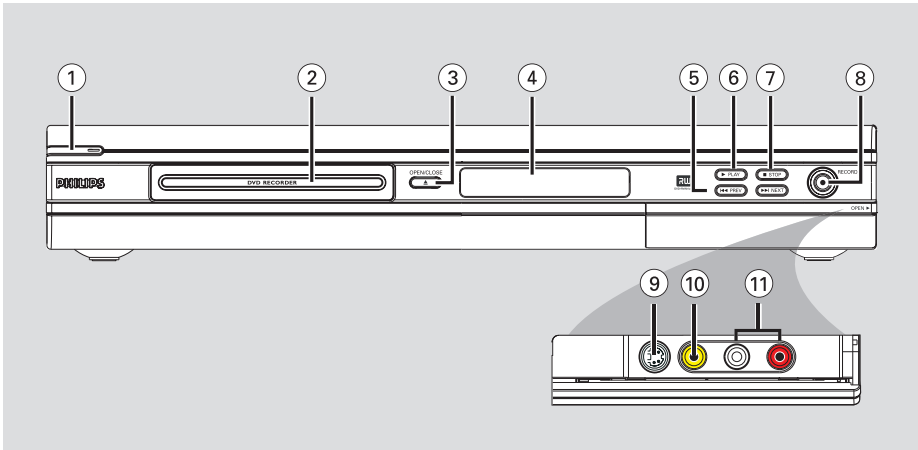
English



- ① **STANDBY-ON** 
 - Turns on or off the DVD recorder.
- ② **Disc tray**
 - Disc tray.
- ③ **OPEN CLOSE** 
 - Opens/ closes the disc tray.
- ④ **System display panel**
 - Show information about the current status of the DVD recorder.
- ⑤ **◀◀ PREV / ▶▶ NEXT**
 - Go to the previous/ next chapter or track, do a forward/ reverse search.
- ⑥ **▶ PLAY**
 - Play a disc.
- ⑦ **■ STOP**
 - Stop playback/ recording.
- ⑧ **RECORD** 
 - Start recording the current TV channel or the current video input source.
 - Press repeatedly to set up a One Touch Recording at 30 minutes interval.

Sockets behind the flap



Flip down the door as indicated by the **OPEN**  label at the right hand corner.

- ⑨ **S-VIDEO**
 - S-video input for SVHS/ Hi8 camcorders or SVHS/ Hi8 video recorders. Press **REC SOURCE** on the remote control to select 'Front S-Video' in order to view the input source.
- ⑩ **VIDEO**
 - Video input for camcorders or video recorders. Press **REC SOURCE** on the remote to select 'Front CVBS' in order to view the input source.
- ⑪ **L/R AUDIO**
 - Audio input for camcorders or video recorders.

Remote Control

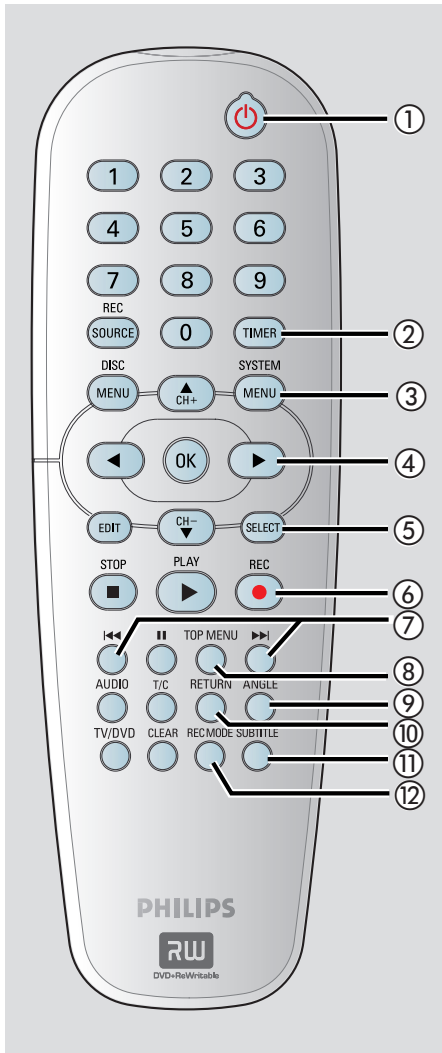
English



- ① **STANDBY-ON** 
 - Turns on the DVD recorder or to standby mode.
- ② **TIMER**
 - Enters/ exits the timer recording menu.
- ③ **SYSTEM-MENU**
 - Enters/ exits the system menu.
- ④ **◀▶** : Cursor buttons for moving to the left or right, do a forward/ reverse search.
▲▼ : Cursor buttons for moving up/ down or changing the recorder's TV tuner channel.
- ⑤ **SELECT**
 - Selects a track/ chapter/ file in the programme menu.
- ⑥ **REC** 
 - Starts recording the current TV channel or the current video input source.
- ⑦ **⏮ ⏭**
 - Skips to previous or next Chapter/ Track.
- ⑧ **TOP MENU** (For DVD±R/±RW discs only)
 - Enters the disc editing menu.
- ⑨ **ANGLE**
 - Selects a DVD disc camera angle (if available).
- ⑩ **RETURN**
 - Returns to the previous menu of a video CD (VCD) or some DVDs.
- ⑪ **SUBTITLE**
 - Selects a DVD subtitle language.
- ⑫ **REC MODE**
 - Toggles between recording modes : 1, 2, 4 and 6 hour mode.
This determines the quality of the recording and the amount/ length of time you can record on a DVD±R/±RW.

Remote Control (continued)

English

- ⑬ **Numeric keypad**
 - Selects a chapter/ track number to play.
 - Selects the recorder's preset TV tuner channel.
- ⑭ **REC SOURCE**
 - Selects the recorder's input source.
- ⑮ **DISC-MENU**
 - Access DVD disc menu or Index Picture screen of a DVD±R/±RW.
 - Access VCD disc menu when PBC is turned on.
- ⑯ **OK**
 - Stores/ confirms an entry.
 - Displays/ removes the status bar.
- ⑰ **EDIT** (For DVD±R/±RW discs only)
 - Enters/ exits the video editing menu.
- ⑱ **PLAY ►**
 - Plays a disc.
- ⑲ **STOP ■**
 - Stops playback/ recording.
 - Holding down the button will open/ close the disc tray.
- ⑳ **II**
 - Pauses the playback or recording.
 - Press repeatedly to advance a paused picture one frame at a time.
- ㉑ **AUDIO**
 - Selects an audio language (DVD, VCD) or an audio channel.
- ㉒ **T/C** (Title/ Chapter)
 - Enters/ exits the T/C menu.
- ㉓ **TV/DVD**
 - Switch between playback from the additional devices [connected via the EXT2 AUX I/O socket] and playback from the DVD recorder.
- ㉔ **CLEAR**
 - Clears a track/ chapter/ file in the programme menu.
 - Clears a timer entry.

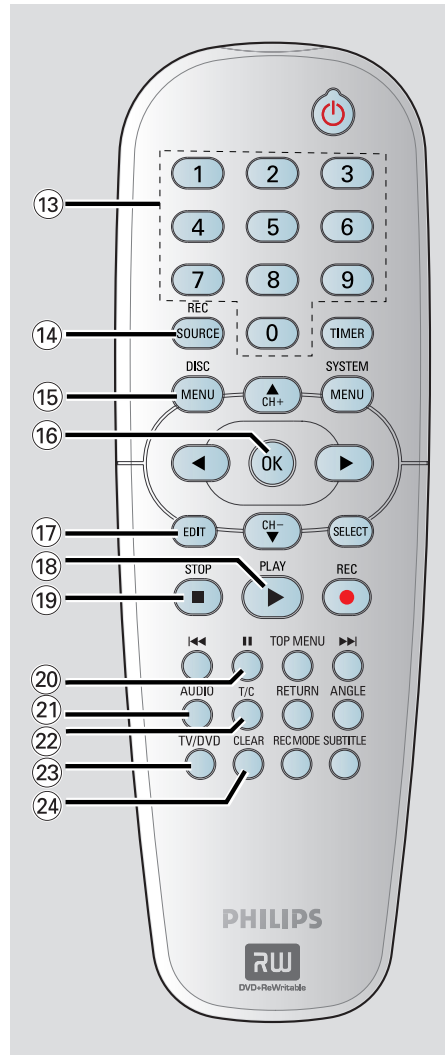

Getting Started

Step 1: Inserting Batteries

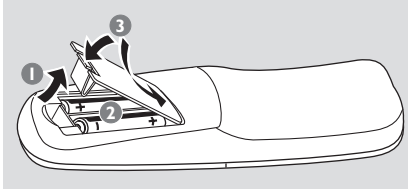

- 1 Open the battery compartment.
- 2 Insert two batteries type R06 or AA, following the indications (+ -) inside the compartment.
- 3 Close the cover.

CAUTION!

- Remove batteries if they are exhausted or if the remote is not to be used for a long time.
- Do not use old and new or different types of batteries in combination.
- Batteries contain chemical substances, so they should be disposed off properly.

Using the remote control to operate the system

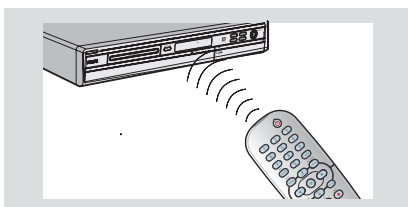

- 1 Aim the remote control directly at the remote sensor (IR) on the front panel.
- 2 Press **REC SOURCE** on the remote control to select the mode you wish to control (for example TUNER, Front-CVBS).
- 3 Then select the desired function (for example ◀◀, ▶▶).

Step 2: Finding the viewing channel

- 1 Press **STANDBY-ON**  on the DVD recorder to turn it on.
- 2 Turn on the TV and set it to the correct video-in channel. You should see the blue DVD background screen.
 - Usually this channel is between the lowest and highest channels and may be called FRONT, A/V IN, VIDEO. See your TV's user manual for more details.
 - You may go to Channel 1 on your TV, then press the Channel down button repeatedly until you see the Video In channel.
 - The TV remote control may have a button or switch that chooses different video modes.

IMPORTANT!

When you complete the connections and turn on the DVD recorder for the first time, it is advisable that you make several basic settings.

Please see the following pages on using the System Menu features to programme TV channels and menu language settings. This will improve the performance of this DVD recorder considerably.

Getting Started (continued)

Step 3: Select the country of your residence

Select the country of your area for auto channel tuning.

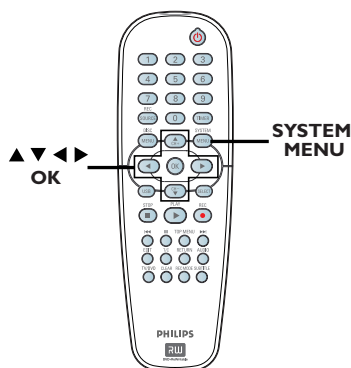

- 1 Press **SYSTEM-MENU** on the remote control.
→ The system menu appears on the TV.
- 2 Use ▲▼ keys to highlight  { **System Menu - General** } and press ►.

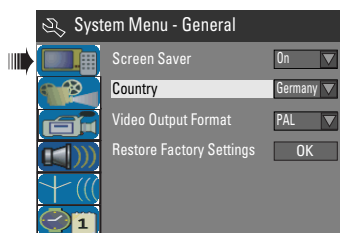

- 3 Use ▲▼ keys to highlight { **Country** } and press **OK**.
- 4 Use ▲▼ keys to select the country of your residence and press **OK** to confirm.

Step 4: TV channel programming

Before the DVD recorder can start recording the TV channel programmes, you need to search for the available TV channels and store them in the recorder.

Note: Make sure you have successfully made all the required connections to the DVD recorder, the TV and Satellite Receiver/ Cable Box (if any) and switched them on before proceeding.

Tuner settings can only be changed when there is no disc in the disc tray.

Automatic TV channel search

This function will automatically scan all the receivable analogue local TV channels and store these channels on the DVD recorder.

- 1 Press **SYSTEM-MENU** on the remote control.
→ The system menu appears on the TV.
- 2 Use ▲▼ keys to highlight  { **System Menu - Channel Setup** } and press ►.

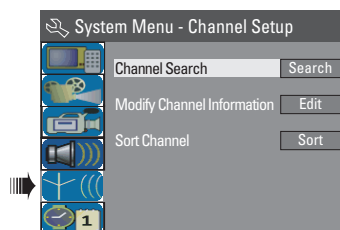

- 3 Use ▲▼ keys to highlight { **Channel Search** } and press **OK**.
→ The automatic TV channel search starts.
This process may take several minutes. Once complete, the total number of channels found will appear on the TV.

TIPS: Press ◀ to go back to previous menu item.
Press **SYSTEM-MENU** to exit the menu.

Getting Started (continued)

Modifying Channel Information

You can set a TV channel to your preference and improve the reception and the sound quality of the TV channel.

- 1 Press **SYSTEM-MENU**.
→ The system menu appears.
- 2 Use **▲▼** keys to highlight  { **System Menu - Channel Setup** } and press **▶**.
- 3 Use **▲▼** keys to highlight { **Modify Channel Information** } and press **OK**.
→ The channel menu appears.

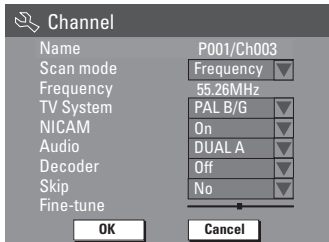

- 4 Use **▲▼** keys to select one of the options and press **OK**.

{ Name }

You can use the **numeric keypad 0-9** to select the channel preset number which you wish to change.

- Use **▲▼** keys to change alphabet/number and use **◀▶** keys to select different entry fields, then press **OK** to confirm.

{ Scan Mode }

Select TV channel search mode based on channel allocation or frequency.

- Use **▲▼** keys to select { **Channel** }, { **S-Channel** } (Special Channel) or { **Frequency** }, then press **OK** to confirm.

{ Frequency }

Shows the frequency of the current TV channel.

- If required, use **◀▶** keys to start the automatic frequency search and press **OK** to confirm.

{ TV System }

Set the TV system that produces the least distortion of picture and sound.

- Use **▲▼** keys to select a suitable sound mode, then press **OK** to confirm. (See chapter “TV System Guide” at the back of this manual for more information).

{ NICAM }

Turn on or off the digital sound transmission system which improves the sound quality of the TV channel.

- Use **▲▼** keys to select { **On** } or { **Off** }, then press **OK** to confirm.

{ Audio }

For bilingual TV programmes, you can switch between stereo (original) and additional audio language.

- Use **▲▼** keys to select { **Dual A** } or { **Dual B** }, then press **OK** to confirm.

{ Decoder }

If you have connected the DVD recorder to an external decoder, select { **On** } and press **OK** to confirm.

{ Skip }

Select this to set the channel to be skipped.

- The skipped channels can only be accessed by pressing the corresponding number button on the remote control.
- Use **▲▼** keys to choose { **Yes** } if you wish to skip this channel, then press **OK** to confirm.

{ Fine Tune }

Select this to fine-tune the TV channel manually if the reception is poor.

- Use **◀▶** keys to adjust the frequency.

- 5 Once complete, select in the menu and press **OK** to confirm and exit to the previous menu page.
→ If you do not wish to save any changes, select and press **OK**.

TIPS: Press **◀** to go back to previous menu item. Press **SYSTEM-MENU** to exit the menu.

Getting Started (continued)

Sorting the TV channels

You may not agree with the sequence in which the individual TV channels have been allocated to the programme numbers. You can use this function to rearrange all the stored TV channels.

- 1 Press **SYSTEM-MENU**.
→ The system menu appears.
- 2 Use ▲▼ keys to highlight  { **System Menu - Channel Setup** } and press ►.
- 3 Use ▲▼ keys to highlight { **Sort Channels** } and press **OK**.
→ The list of TV channel programmes appears.

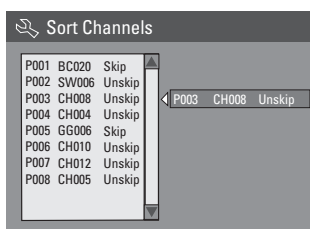

- 4 Use ▲▼ keys to highlight the channel you want to change and press **OK**.
→ The selected channel will move to the right side of the screen.
- 5 Use ▲▼ keys to shift the TV channel to the desired position and press **OK** again.
→ The selected channel will be inserted before the current position.
- 6 Repeat steps 4~5 until you have sorted all the TV channels you want.
- 7 Press **RETURN** on the remote control to go back to the previous menu.

TIPS: Press ◀ to go back to previous menu item.
Press **SYSTEM-MENU** to exit the menu.

Step 5: Setting the language

You can select the language for subtitles and audio for DVD playback. For some DVDs, the subtitle/ audio language can only be changed via the DVD disc menu. If the selected language is not available on the disc, the disc's default language will be used instead.

The menu language (on-screen display) for the system will remain as you set it.

Language settings can only be changed when there is no disc in the disc tray.

- 1 Press **SYSTEM-MENU**.
→ The system menu appears.
- 2 Use ▲▼ keys to highlight  { **System Menu - Language** } and press ► to confirm.

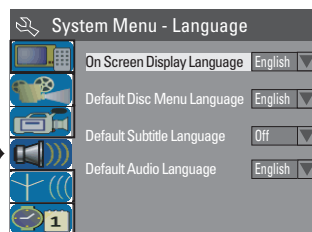

- 3 Use ▲▼ keys to highlight one of the options and press **OK**.
{ **On Screen Display Language** }
Select this to change the language of this DVD recorder screen display menu.
{ **Default Disc Menu Language** }
Select this to change the language of the Disc Menu.
{ **Default Subtitle Language** }
Select this to change the subtitle language.
{ **Default Audio Language** }
Select this to change the playback language.
- 4 Use ▲▼ keys to highlight the desired language and press **OK** to confirm.

Getting Started (continued)

Step 6: Setting the time & date

If the DVD recorder has not set the time and date correctly, set the clock manually by following the steps below.

- 1 Press **SYSTEM-MENU**.
→ The system menu appears.
- 2 Use ▲▼ keys to select  { **System Menu - Clock** } and press ► to confirm.

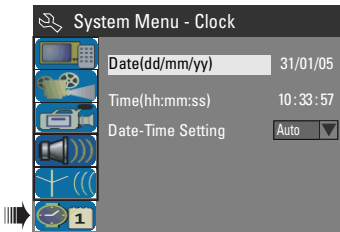

- 3 Press **OK** to set { **Date(dd/mm/yy)** }.
- 4 Use ▲▼ keys to change number and use ◀▶ keys to select different entry fields, then press **OK** to confirm.
- Alternatively, you can key in the numbers using the **numeric keypad 0-9** on the remote control.
- 5 Press **OK** to confirm.
- 6 Move to { **Time (hh:mm:ss)** } and repeat step 4~5.

TIPS: Press ◀ to go back to previous menu item.
Press **SYSTEM-MENU** to exit the menu.

Discs for recording

Several different formats of DVD recordable discs can be used with this DVD recorder:



DVD±RW (DVD Rewritable)

– Discs that are re-writable can be used for multiple recordings once existing data is erased.



DVD±R (DVD Recordable)

– Discs can only be used for a single recording. Each new recording is always added at the end of all previous recordings as existing recordings cannot be overwritten.

– Editing can be made on any DVD±R discs as long as they have not been finalised. It is also possible to create additional chapter markers.

– You can also delete any unwanted recordings. However, the disc space occupied by the deleted recordings cannot be recovered for further recording.

– To play a DVD±R on other DVD player, it must be finalised (see page 36 “Playing your recordings (DVD±R) on other DVD players”). After this is done, no more data can be added to the disc.

IMPORTANT!

Unrecordable pictures

Television programmes, films, video tapes, discs, and other materials may be copy-protected and therefore cannot be recorded on this recorder.

Recording settings

The default recording settings allow you to set the auto chapter markers, preferred recording input source and recording mode. Any changes made using the remote control will only apply to the current recording settings, the default recording settings will remain unchanged for the next recording.

- 1 Press **SYSTEM-MENU** on the remote control.
→ The system menu appears on the TV.
- 2 Use **▲▼** keys to select { **System Menu - Record** } and press **▶** to confirm.

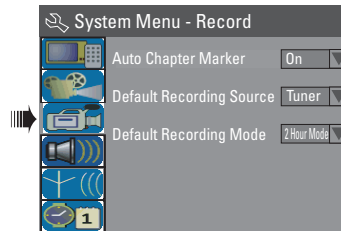

- 3 Use **▲▼** keys to select the setting you wish to change and press **OK** to confirm.
→ Instructions and explanation of the options are provided in the following pages.
- 4 To exit, press **SYSTEM-MENU**.

TIPS: Press **◀** to go back to previous menu item.
Press **SYSTEM-MENU** to exit the menu.

Recording (continued)

Auto Chapter Markers

You can insert chapter markers within a title during recording. This enables you to access specific points on the recorded disc as you would choose a chapter on other DVDs.

- 1 Use **▲▼** keys to select { **Auto Chapter Marker** } and press **▶** to access its options.
- 2 Use **▲▼** keys to select one of the options.
 - { **Off** }
 - Disable this feature.
 - { **On** }
 - A chapter marker will be automatically inserted during recording. The interval depends on the recording mode selected.
- 3 Press **OK** to confirm.

Default Source

You can define your preferred source of recording. The default source is selected when the DVD recorder is turned on. To change the current recording source without changing the default setting, you can press **REC SOURCE** on the remote control.

- 1 Use **▲▼** keys to select { **Default Recording Source** } and press **▶** to access its options.
- 2 Use **▲▼** keys to select one of the options.
 - { **Tuner** }
 - Input source from TV programmes.
 - { **Front CVBS** }
 - Input source from the device connected to the VIDEO and AUDIO L/R sockets on the front panel.

{ Front S-Video }

Input source from the device connected to the S-VIDEO and AUDIO L/R sockets on the front panel.

{ EXT 1 }

Input source from the device connected to the EXT1 TO TV-I/O scart socket on the back panel.

{ EXT 2 }

Input source from the device connected to the EXT2 AUX-I/O scart socket on the back panel.

- 3 Press **OK** to confirm.

Default Recording Mode

The recording mode defines the picture quality of recordings and the maximum recording time for a disc.

This function can also be accessed via the **REC MODE** button on the remote control.

- 1 Use **▲▼** keys to select { **Default Recording Mode** } and press **▶** to access its options.
- 2 Use **▲▼** keys to select one of the following recording mode.

Maximum Recording Time per Disc	Picture Quality	Record Mode
1 hour	High quality	1 Hour Mode
2 hours	DVD quality-Standard Play	2 Hour Mode
4 hours	VHS quality-Extended Play	4 Hour Mode
6 hours	VHS quality-Super Long Play	6 Hour Mode

- 3 Press **OK** to confirm.

TIPS: The underlined option is the factory default setting.
Press **◀** to go back to previous menu item. Press **SYSTEM-MENU** to exit the menu item.

Recording (continued)

Manual recording

Use this feature to start recording immediately (e.g., to record a TV show already in progress).

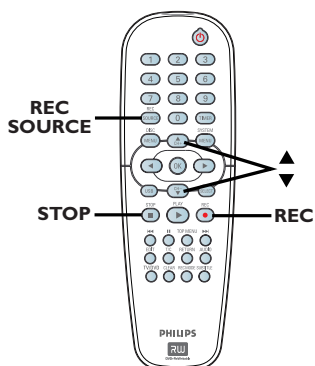

- 1 Turn on the TV power. Select the correct Video In channel at the TV.
 - 2 Insert a recordable DVD±R/±RW into the DVD recorder.
 - 3 Press **REC SOURCE** on the remote control to select { **Tuner** }, then use ▲▼ keys to select the TV channel you wish to record.
- OR
- To record from an external device, press **REC SOURCE** repeatedly to select the external channel that you wish to record from.

{ Front CVBS }

Input source from the device connected to the VIDEO and AUDIO L/R sockets on the front panel.

{ Front S-Video }

Input source from the device connected to the S-VIDEO and AUDIO L/R sockets on the front panel.

{ EXT 1 }

Input source from the device connected to the EXT1 TO TV-I/O scart socket on the back panel.

{ EXT 2 }

Input source from the device connected to the EXT2 AUX-I/O scart socket on the back panel.

- 4 Press **REC** ● to start recording.
→ The recording will automatically start after the last recording on the DVD±R/±RW.
- 5 To stop the recording, press **STOP** ■.

Pausing a recording

- 1 During a recording, press **II**.
→ You can use this function to avoid recording commercials.
- 2 To resume recording, press **REC** ●.

One Touch Recording - automatic turn-off

- 1 Follow the steps 1~3 of "Manual Recording" on page 29.
- 2 Press **REC** ● twice to start a 30 minutes recording. Each time you press **REC** ● after that, you will add 30 minutes to the recording time.
→ The recorder will stop recording at the designated end time and turn off automatically.
- Press **STOP** ■ if you wish to stop the recording.

TIPS: Ensure that there is sufficient space available on the DVD±R/±RW before recording. You have to finalise the DVD±R before it can be played on other players, see page 36.

Recording (continued)

About timer recording

Use 'Timer Recording' to automatically start and stop a recording at a later date/ time. The DVD recorder will tune to the right programme channel and begin recording at the specified time.

With this DVD recorder, you can preprogramme up to **8 recordings**.

To make a timer recording, your DVD recorder needs to know:

- The date you want to make the recording.
- The recording input source.
- The start and stop time of the recording.
- The recording mode, see page 28.

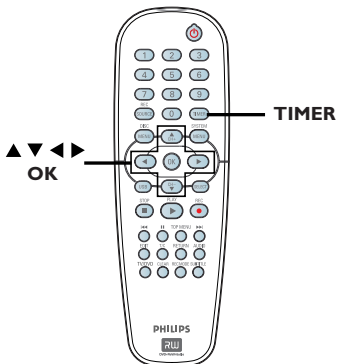

About 'VPS/PDC'

'VPS' (Video Programming System) or 'PDC' (Programme Delivery Control) is used to control the start and duration of TV channel recordings. If a TV programme starts earlier or ends later than was scheduled, the DVD recorder will then switch on and off at the correct time.

VPS/PDC is intended to record the entire programme. To set a timer that is longer/ shorter than the VPS/PDC broadcast time, you must turn off the VPS/PDC.

TIPS: Ensure that there is sufficient space available on the DVD±R/±RW before recording. You have to finalise the DVD±R before it can be played on other players, see page 36.

Timer recording (manually)

- 1 Turn on the TV power. Select the correct Video In channel at the TV.
- 2 Press **TIMER** on the remote control.
 - The timer schedule list appears.

	Source	RecMode	Date	Start	End	VPS
1						
2						
3						
4						
5						
6						

- 3 Press **OK** on the remote control.
 - The VIDEO PLUS+® System menu appears.

VIDEO Plus+ System

Enter the VIDEO Plus+ programming number for the show you wish to record. Press CANCEL to return to timer schedule or [TIMER] to exit timer.

5

Confirm Cancel

- 4 Select **CANCEL** in the menu and press **OK**.
 - The timer editor menu appears.

Timer Editor

Source Ch003

Rec Mode 2 Hour Mode

Mode Once

Date 31 / 01 / 05

Start 12 : 33

End 13 : 03

VPS Off

OK Cancel

- 5 Use **▲▼** keys to select an entry in the menu and press **▶** to enter its options.

Recording (continued)

{ Source }

– Use ▲▼ keys to select the recording input source.

{ Rec Mode }

– Use ▲▼ keys to select your option.
See pages 27~29 on “Recording settings - Default Recording mode”.

{ Mode }

– Use ▲▼ keys to select { **Once** }, { **Daily** }, { **Weekly** }, { **Mon-Fri** } (Monday to Friday,) { **Mon-Sat** } (Monday to Saturday) or { **Weekend** } (Saturday and Sunday) recordings.

{ Date }

– Use ▲▼ keys or the **numeric keypad 0-9** to enter the date for recording.

{ Start }

– Use ▲▼ keys or the **numeric keypad 0-9** to enter the start time of recording.

{ End }

– Use ▲▼ keys or the **numeric keypad 0-9** to enter the end time of recording.

{ VPS }

– Use ▲▼ keys to turn on/off the VPS mode (see page 30 on “About VPS/PDC”).

- 6 Select in the menu and press **OK**.
→ The system will store the timer entry and return to the timer schedule list.
- To cancel the above timer setting, select in the menu and press **OK**.
- 7 Press **TIMER** to exit the menu.
- 8 Insert a DVD±R/±RW into the DVD recorder.

- 9 Press **STANDBY-ON** to turn off the DVD recorder.
→ If the DVD recorder is not in standby mode, a warning message will appear three minutes before the recording starts.
→ If you ignore the warning message, the DVD recorder will automatically switch to standby mode to prepare for timer recording at the designated time.
→ The ‘**TIMER**’ icon will light up on the display panel if a timer recording is set.

Helpful Hint:

– Set the timer recording one minute ahead of the programme’s start time. This helps ensure the entire programme is recorded as the disc requires about 30 seconds to prepare for recording.

Setting a timer recording from an external Cable Box/Satellite Receiver

If you have a Satellite Receiver/Cable Box connected to this DVD recorder via the EXT2 AUX-I/O scart connection (see page 15), follow the steps described below to programme the recordings.

- 1 Select the channel you want to record at the Satellite Receiver/Cable Box.
- 2 Programme the recording with the required information. Follow the steps ①~⑨ of “Timer Recording (manually)” on pages 30~31.

{ Source }

– Use ▲▼ keys to select { **EXT2** } as the input channel and press **OK** to confirm.

- 3 Leave the Satellite Receiver/Cable Box on for the recording.

Helpful Hint:

– The Cable Box/ Satellite has to be turned on before timer recording starts. Recording will proceed but as there is no signal, the recording will be blank.

TIPS: Ensure that there is sufficient space available on the DVD±R/±RW before recording. You have to finalise the DVD±R before it can be played on other players, see page 36.

Recording (continued)

Timer recording (VIDEO Plus+® System)

This is a simple programming system for DVD recorders. To use it, enter the VIDEO Plus+® programming number associated with your television programme. You can find this number in your TV listings magazine.

All the information needed by the DVD recorder for programming is contained in the programming number.

- 1 Turn on the TV power. Select the correct Video In channel at the TV.
- 2 Press **TIMER** on the remote control.
→ The timer schedule list appears.

	Source	RecMode	Date	Start	End	VPS
1						
2						
3						
4						
5						
6						

- 3 Press **OK** to confirm.
Or, press **▼** key to go to the next available empty slot and press **OK**.
→ The VIDEO Plus+® System menu appears.

VIDEO Plus+ System

Enter the VIDEO Plus+ programming number for the show you wish to record. Press CANCEL to return to timer schedule or [TIMER] to exit timer.

5

Confirm Cancel

- 4 Use the **numeric keypad 0-9** to enter the VIDEO Plus+® programming number for the show you wish to record. (e.g. : 5-312-4 or 5,312 4, key in '53124').

TIPS: Ensure that there is sufficient space available on the DVD±R/±RW before recording. You have to finalise the DVD±R before it can be played on other players, see page 36.

- To clear the VIDEO Plus+® programming number, press **CLEAR** on the remote control.
- To cancel the VIDEO Plus+® programming, use **▲▼** keys to select **CANCEL** in the menu and press **OK**.
- 5 To confirm your entry, select **CONFIRM** in the menu and press **OK**.
→ The system will store the timer entry and return to the timer editor menu.
- If the channel number of the TV channel has not been assigned to the programming number, you will have to manually key in the channel number that is assigned to the VIDEO Plus+® code. Follow the instructions on the TV.
- 6 Press **TIMER** to exit the menu.
- 7 Insert a DVD±R/±RW into the DVD recorder.
- 8 Press **STANDBY-ON** to turn off the DVD recorder.
→ If the DVD recorder is not in standby mode, a warning message will appear three minutes before the recording starts.
→ If you ignore the warning message, the DVD recorder will automatically switch to standby mode to prepare for timer recording at the designated time.
→ The '**TIMER**' icon will light up on the display panel if a timer recording is set.

Recording (continued)

Changing/ Deleting a timer recording

- 1 Turn on the TV power. Select the correct Video In channel at the TV.
- 2 Press **TIMER** on the remote control.
→ The timer schedule list appears.

Timer Schedule						
	Source	RecMode	Date	Start	End	VPS
1	CH003	2 Hour Mode	14/01/05	14.00	15.30	On
2	CH010	1 Hour Mode	25/01/05	02.00	06.30	Off
3	CH008	4 Hour Mode	30/01/05	17.00	20.15	On
4	CH005	2 Hour Mode	31/01/05	12.30	14.00	Off
5						
6						

- 3 Use **▲▼** keys to select a timer programme which you want to change/ delete.
- 4 **To delete the timer entry**, press **CLEAR** on the remote control.
- 5 **To change the timer schedule**, press **OK** to enter the timer editor menu of the selected timer programme.

Timer Editor	
Source	Ch003
Rec Mode	2 Hour Mode
Mode	Once
Date	31 / 01 / 05
Start	12 : 33
End	13 : 03
VPS	Off
<input type="button" value="OK"/> <input type="button" value="Cancel"/>	

- 6 Select the entry field and make the necessary changes.
- 7 Once complete, select in the menu and press **OK** to save the changes.
- 8 Press **TIMER** to exit the menu.

TIPS: Ensure that there is sufficient space available on the DVD±R/±RW before recording. You have to finalise the DVD±R before it can be played on other players, see page 36.

Simultaneous recording and playback

While recording is in progress, you can watch another TV channel or the playback from other audio/video device which is connected to this DVD recorder.

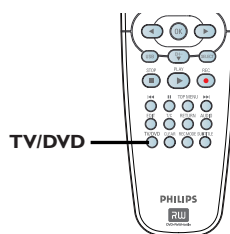

Watching playback from other device

This is only possible if the DVD recorder is connected to the TV using the EXT1 TO TV-I/O socket.

- Press **TV/DVD** to view the picture from the device which is connected to the EXT2 AUX-I/O socket of this DVD recorder.

Watching another TV channel

If there is no device connected to the EXT2 AUX-I/O socket, pressing **TV/DVD** will switch to TV mode.

- Use the TV's remote control to change the channels.
→ The message "TV/LOOP" will be displayed on the recorder's system display panel.
- To return to viewing playback from the DVD recorder, press **TV/DVD** on the remote control

Helpful Hint:

– Remember to switch the TV back to its video input channel if you want to watch the TV channel through the DVD recorder or playback the recorded disc.

Editing/Finalising Recording

About disc editing

This DVD recorder offers various disc edit options for various disc types. You can change the disc content and settings of a recorded DVD±R/±RW from the disc editing menu. The edited contents may not be available when you play the disc on another DVD player.

The displayed options in the disc editing menu may differ depending on the type of disc.

{ Play }

Start playing from the beginning of the disc.

{ Rename Disc }

Change the name of the disc.

{ Erase Disc } - DVD±RW only

Erase all the recordings on the disc.

{ Record New Title }

Start recording from the last empty title in the disc.

{ Overwrite Disc } - DVD±RW only

Start a new recording from the beginning of the disc, all the recorded content will be overwritten.

{ Make Compatible } - DVD±RW only

To ensure the edited changes remain when the disc is played back on another DVD player. (eg., hidden chapters to remain hidden.)

{ Lock/Unlock Disc } - DVD±RW only

Lock or unlock a disc to prevent accidental erasure or changes being made.

{ Finalise Disc } - DVD±R only

Finalise the disc to enable playback on other DVD players. Further recording and editing to the disc are not allowed. It is not possible to unfinalise the disc.

Accessing disc editing menu

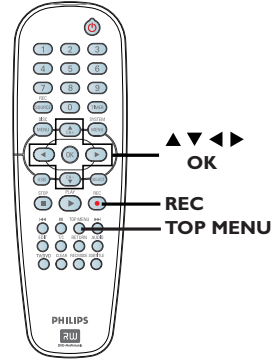

- 1 Insert a recorded DVD±R/±RW into the DVD recorder.
→ The Index Picture screen appears on the TV.
- 2 Press **TOP MENU** on the remote control.
→ The disc editing menu appears. The available editing options are different for DVD±R and DVD±RW discs.



- 3 Use ▲▼ keys to access different options and **OK** to select.
→ Instructions and explanation of the options are provided in the following pages.
- 4 Press **DISC MENU** to go back to the disc Index Picture screen.

TIPS: No further recording and editing can be carried out on a full or finalised DVD±R. Press ◀ to go back to previous menu item. Press **DISC MENU** to exit.



Editing/Finalising Recording (continued)

Rename disc

The original disc name is generated automatically by the DVD recorder. You can change the disc name by following the steps below.

- 1 Press **TOP MENU**, use **▲▼** keys to select { **Rename Disc** } and press **OK**.
→ The keyboard screen appears.
 - 2 Use **◀▶▲▼** keys to highlight a character on the keyboard and press **OK** to select.
→ The maximum input is up to 9 characters.
- You can use the following keys on the keyboard screen to edit your input:
 - BkSp** : to remove the character to the left of the cursor.
 - DELETE** : to remove the character to the right of the cursor.
 - SPACE** : to create a space between characters.
 - CAPS** : to toggle between upper and lowercase characters.
 - CLEAR** : to clear the entry field completely.
 - 3 To confirm your entry, select **OK** on the keyboard and press **OK**.
→ The info panel is now updated.
 - To cancel the changes, select **EXIT** on the keyboard and press **OK**.

Erase disc (DVD±RW only)

This erases the content of the DVD±RW including those that was not recorded on this DVD recorder. Once the existing content is erased, the disc can be used for recording again.

- 1 Press **TOP MENU**, use **▲▼** keys to select { **Erase Disc** } and press **OK**.
→ A warning message will appear.
- 2 Select **YES** in the menu to proceed or **NO** to abort, then press **OK** to confirm.

Record new title

This function allows you to start a new recording at the remaining empty space in the DVD±RW.

- 1 Press **TOP MENU**, use **▲▼** keys to select { **Record New Title** } and press **OK**.
- 2 Select the source you want to record from and press **REC ●** to start recording.

Overwrite disc (DVD±RW only)

This function allows you to start a new recording from the beginning of a DVD±RW regardless of the contents of the disc.

- 1 Press **TOP MENU**, use **▲▼** keys to select { **Overwrite disc** } and press **OK**.
- 2 Select the source you want to record from and press **REC ●** to start recording.

TIPS: No further recording and editing can be carried out on a full or finalised DVD±R. Press **◀** to go back to previous menu item. Press **DISC MENU** to exit.



Editing/Finalising Recording (continued)

Make compatible (DVD±RW only)

The edited DVD±RW may still display the original titles or hidden scenes when played back on other DVD players. This function ensures that the edited changes of the DVD±RW remain when played back on other players.

- Press **TOP MENU**, use **▲▼** keys to select { **Make Compatible** } and press **OK** to confirm.

Helpful Hint:

– If the option { *Compatible* } is not available for selection, it means that the disc is already compatible.

Lock/Unlock disc (DVD±RW only)

You can choose to protect the recorded DVD±RW in order to prevent accidental loss of recordings.

- 1 Press **TOP MENU**, use **▲▼** keys to select { **Lock Disc** } and press **OK**.
→ The disc is locked for this DVD recorder only.
→ When the disc is locked, the option in the disc editing menu will change to { **Unlock Disc** }.
- 2 If you want to overwrite or edit on the protected disc, select { **Unlock Disc** }.

Playing your recordings (DVD±R) on other DVD players

It is necessary to finalise a DVD±R disc before you can play it on any other DVD player. Otherwise, the DVD±R will only playback on this DVD recorder.

After a DVD±R disc has been finalised, no further recordings or editing can be made to it. Make sure that you have completed all the recordings and editing before finalising the disc.

- 1 Press **TOP MENU**, then use **▲▼** keys to select { **Finalise Disc** } and press **OK**.
→ A warning message will appear.
- 2 Select in the menu and press **OK** to start the process.
→ Finalisation will take a few minutes. Do not try to open the disc tray or turn the power off as this may render the disc unusable.
- 3 Select to abort.

TIPS: No further recording and editing can be carried out on a full or finalised DVD±R. Press **◀** to go back to previous menu item. Press **DISC MENU** to exit.

Editing/Finalising Recording (continued)

About title editing

You can change the individual title information or delete a title (recording) on a recorded DVD±R/±RW. If a DVD±R has been finalised, it cannot be edited.

The displayed options in the title editing menu differ depending on the situation and disc type.

{ Play Title }

Start playing a recording.

{ Edit Title }

Access video editing menu.

{ Rename Title }

Change the name of the recording.

{ Erase Title } - DVD±RW only

Delete the title (recording).

{ Overwrite Title } - DVD±RW only

Start a new recording, the existing title (recording) will be overwritten.

{ Overwrite Disc } - DVD±RW only

Overwrite from existing selected title onwards to the end of the disc.

{ Append Title }

Insert a new recording to the last existing recording.

Accessing title editing menu

- 1 Insert a recorded DVD±R/±RW into the DVD recorder.
→ The Index Picture screen appears on the TV.
- 2 During playback, press **DISC MENU** to access the Index Picture screen.
● Use **▲▼** keys to highlight a title (recording), and press **▶**.
→ The title editing menu appears.



- 3 Use **▲▼** keys to access different options and **OK** to select.
→ Instructions and explanation of the options are provided in the following pages.
- 4 To exit, press **◀**.

Video editing

This feature allows access to the video editing menu. See “About video editing” on pages 39–41 for more information.

- In title editing menu, use **▲▼** keys to select { **Edit Title** } and press **OK**.
→ The video editing menu appears.
→ The DVD recorder will play the selected title.

TIPS: No further recording and editing can be carried out on a full or finalised DVD±R. Press **◀** to go back to previous menu item.

Editing/Finalising Recording (continued)

Rename title

The original title name is generated automatically by the DVD recorder. You can give a new name to the title by following the steps below.

- In title editing menu, use ▲▼ keys to select { **Rename Title** } and press **OK**.
→ The keyboard screen appears.
- Use ◀▶ ▲▼ keys to highlight a character and press **OK** to select.
→ The maximum input is up to 9 characters.
- You can use the following keys on the keyboard screen to edit your input:
 - : to remove the character to the left of the cursor.
 - : to remove the character to the right of the cursor.
 - : to create a space between characters.
 - : to toggle between upper and lower case characters.
 - : to clear the entry field completely.
- To confirm your entry, select on the keyboard and press **OK**.
→ The info panel is now updated.
- To cancel the changes, select on the keyboard and press **OK**.

Erase title

You can delete a specific title (recording) from the disc.

- In title editing menu, use ▲▼ keys to select { **Erase Title** } and press **OK**.
→ A warning message will appear.
- Select in the menu to proceed or to abort, then press **OK** to confirm.

Overwrite title (DVD±RW only)

This function allows you to record a new title from the beginning of the current title in the DVD±RW. The other titles will not be affected.

- In title editing menu, use ▲▼ keys to select { **Overwrite Title** } and press **OK**.
- Select the source you want to record from and press **REC ●** to start recording.

Overwrite from the selected title

You can choose to overwrite only the recordings from the selected title to the end of the disc.

- In video editing menu, use ▲▼ keys to select { **Overwrite Disc** } and press **OK** to delete.

Append recording

This function allows you to append recording to the last existing title.

- In title editing menu, use ▲▼ keys to select { **Append Title** } and press **OK**.
- Press **REC SOURCE** to select the input channel to append.
- Press **REC ●** to start append recording.
Warning! Once the recording has started, any prior recording from the point of the playback onwards will be overwritten.
- To stop append recording, press **STOP ■**.

TIPS: No further recording and editing can be carried out on a full or finalised DVD±R. Press ◀ to go back to previous menu item.

Editing/Finalising Recording (continued)

About video editing

After a recording has been made, this DVD recorder allows you to edit the video content. You can add/delete chapter markers, hide unwanted scenes, change the picture in the index picture screen and split one title (recording) into two.

When you playback a recording in video edit mode, the entire recording will be played back including hidden scenes.

The edit functions available in the disc editing menu are:

{ Title }

Select a title (recording) to play.

{ Chapter }

Select a chapter within the selected title.

{ Chapter Marker }

Insert a chapter marker in the recording or erase a chapter marker to combine two chapters.

{ Hide Chapter }

Hide the unwanted scene in the recording.

{ Index Picture }

Select a scene in the recording as the index picture screen.

{ Split Title } - DVD±RW only

Divide the recording into two under separate title.

Accessing video editing menu

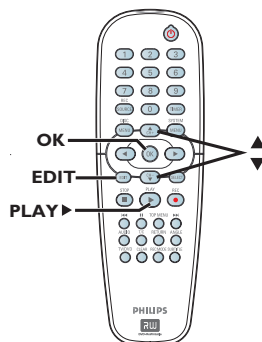

- 1 Insert a recorded DVD±R/±RW into the DVD recorder.
→ The Index Picture screen appears on the TV.
- 2 Use ▲▼ keys to select a title (recording).
- 3 Press **PLAY** ► to start playback.
- 4 Press **EDIT** on the remote control.
→ The video editing menu appears.

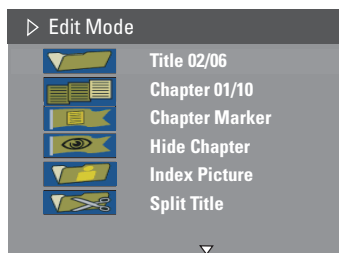

- 5 Use ▲▼ keys to access different options and press **OK** to select.
→ Instructions and explanation of the options are provided in the following pages.
- 6 To exit, press **EDIT**.

TIPS: No further recording and editing can be carried out on a full or finalised DVD±R. Press ◀ to go back to previous menu item.

Editing/Finalising Recording (continued)

Selecting a title

It shows the current title and the total number of titles in the disc. It also allows you to select another title.

- 1 During playback, press **EDIT** to display the video editing menu, then use **▲▼** keys to select  { **Title** } and press **OK**.
- 2 Use the **numeric keypad 0-9** to key in a title and press **OK**.
→ The DVD recorder will play the selected title.

Selecting a chapter

It shows the current chapter and the total number of chapters in the title. It also allows you to select another chapter within the title.

- 1 During playback, press **EDIT** to display the video editing menu, then use **▲▼** keys to select  { **Chapter** } and press **OK**.
- 2 Use the **numeric keypad 0-9** to key in the chapter and press **OK**.
→ The DVD recorder will play the selected chapter.

Creating chapter marker

You can create a chapter by inserting a chapter marker at any point within a title during playback. This will allow you to access a specific point in the recording easily or set a chapter you wish to hide.

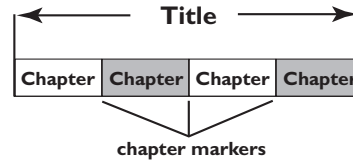

- 1 During playback, press **EDIT** to display the video editing menu, then use **▲▼** keys to select  { **Chapter Marker** } and press **OK**.
- 2 Use **▲▼** keys to select one of the options and press **OK** to confirm.

{ **Insert Marker** }

Select this to insert a new chapter marker at the current point of playback.

{ **Delete Marker** }

Select this to delete the current chapter marker (it refers to the closest marker before the current point of playback). The current chapter will then combine with the chapter before it.

{ **Delete All Markers** }

Select this to delete all the chapter markers in the current title.

TIPS: No further recording and editing can be carried out on a full or finalised DVD±R. Press **◀** to go back to previous menu item.

Editing/Finalising Recording (continued)

Hiding an unwanted chapter

You can choose to hide certain scenes from playback (e.g. skipping a commercial scene) or make it visible again.

- 1 Create a chapter marker at the scene you are going to hide. (See previous page on “Creating chapter marker”).
 - 2 Select the chapter you want to hide and start playback. (See previous page on “Selecting a chapter”).
 - 3 During playback, press **EDIT** to display the video editing menu, then use **▲▼** keys to select  { **Hide Chapter** } and press **OK**.
→ The current chapter will be hidden.
- If the video editing menu does not show, press **EDIT** on the remote control.

To unhide a chapter

- 1 Press **EDIT** on the remote control during playback.
→ The video editing menu appears.
→ While in editing mode, the hidden chapter/chapters will be played back.
- 2 Wait for the chapter you want to unhide to occur or use **◀▶** keys on the remote control to make a fast search.
- 3 Use **▲▼** keys to select { **Unhide Chapter** } and press **OK**.
→ The current chapter will be visible during playback.

Helpful Hints:

- All the hidden chapters will be played back while in video editing mode.
- To locate a specific frame during playback, press **PAUSE** **||** repeatedly to forward search to the frame you want.

Changing Index Picture

The index picture is the picture of the title you will see when the DVD recorder loads up the Index menu. Normally, the first frame of a recording is shown as the title's index picture.

- 1 During playback, use **◀▶** keys on the remote control to search for the scene to use, then press **||**.
→ Pressing **||** again will move forward to next pause scene.
- 2 Press **EDIT** to display the video editing menu, then use **▲▼** keys to select  { **Index Picture** } and press **OK** to select the current scene as the index picture for the title.

Splitting a title (DVD±RW only)

You can divide the current title into two new titles. Each of these titles is characterised by its own index picture.

Warning! Once a title is divided, the process cannot be reversed.

- During playback, press **EDIT** to display the video editing menu, then use **▲▼** keys to select  { **Split Title** } and press **OK** to divide the title at the current playback position.
→ A new title will be shown at the Index Picture screen.

TIPS: No further recording and editing can be carried out on a full or finalised DVD±R. Press **◀** to go back to previous menu item.

Playback

Playable discs

Using this DVD Recorder, you can play and record on the following discs:

Recording and Playback

DVD±RW (DVD ReWritable); can be recorded on repeatedly.



DVD±R (DVD Recordable); can be recorded on only once.



Playback only:

DVD Video (Digital Versatile Disc)



CD-RW (CD-ReWritable) Audio/ MP3/ JPEG contents



CD-R (CD-Recordable) Audio/ MP3/ JPEG contents



Audio CD (Compact Disc Digital Audio)



MP3-Disc



Video CD (Formats 1.0, 1.1, 2.0)



Super Video CD



IMPORTANT!

– If the inhibit icon (**Error**) appears on the TV screen when a button is pressed, it means the function is not available on the current disc or at the current time.

– DVD discs and players are designed with regional restrictions. Before playing a disc, make sure the disc is for the same region as your player.

– Do not push on the disc tray or put any objects other than discs on the disc tray. It may cause the disc player to malfunction.

Inserting a disc

- 1 Press **STANDBY-ON** to turn on the DVD recorder.
- 2 Press **OPEN CLOSE ▲** on the front of the DVD recorder.
→ The disc tray opens.
- 3 Carefully place the disc into the tray with the label facing up, then press **OPEN CLOSE ▲**.
→ Make sure the disc label is facing up. For double-sided discs, load the side as indicated on the label.
- 4 Turn on the TV power. Select the correct Video In channel at the TV (see page 22).
- 5 Playback will start automatically or a dialog will appear on the TV (see next page).

TIPS: Some discs cannot be played on this DVD recorder due to the configuration and characteristics of the disc, or due to the condition of recording and authoring software.

Playback (continued)

Starting disc playback

- Playback will begin automatically. If the disc has its own menu this will be loaded, otherwise the DVD recorder will launch an index screen.
- If the pin code entry dialog appears on the TV, this means that the parental control was activated for the inserted disc (see page 53).
→ Use the **numeric keypad 0-9** on the remote control to enter your pin code (password).
- For more playback features, see pages 46~49 "Additional Playback Features".

Playing a DVD video disc

The DVD disc is usually formatted with a disc menu. You may have to make your selection (e.g., subtitle or audio language) within the disc menu.

- 1 Insert a DVD disc.

If the disc menu appears on the TV

- Use **numeric keypad 0-9** to input your selection or use ◀▶▲▼ keys to select a play option and press **OK** to start playback.

To select the previous or next title/ chapter marker

- During playback, press **T/C** on the remote control to access the T/C menu. Then use ▲▼ keys to select { **Title** } or { **Chapter** } and input your title/ chapter number using the **numeric keypad 0-9**.
- 2 To stop playback, press **STOP ■**.

Playing a (Super) Video CD

(Super) Video CDs may feature 'PBC' (Play Back Control). This allows you to playback the video CDs interactively, following the menu on the display.

- 1 Insert a (Super) Video CD.

If the 'PBC' is on, the disc index menu will appear on the TV

- 2 Use **numeric keypad 0-9** to input your selection or to select a play option.
 - Press **RETURN** on the remote control to return to the previous menu.
 - To turn on/ off the Playback Control mode, press **T/C** on the remote control during playback to access the T/C menu. Then use ▲▼ keys to select { **PBC On** } or { **PBC Off** }.
- 3 To stop playback, press **STOP ■**.

Playing an audio CD

- 1 Insert an audio CD.
 - Playback starts automatically.
 - The track number and elapsed playing time appear on the display panel.
- 2 To stop playback, press **STOP ■**.

TIPS: Some discs cannot be played on this DVD recorder due to the configuration and characteristics of the disc, or due to the condition of recording and authoring software.

Playback (continued)

Playing a DVD±R/±RW disc

- 1 Insert a DVD±R/±RW disc.
→ The Index Picture screen appears.
- 2 Use ▲▼ keys to select a title and press **PLAY ▶** to start playback.
- 3 To stop playback, press **STOP ■**.

Helpful Hint:

– If the message ‘BLANK’ appears on the display panel, this means that there are no recordings on this disc.

Playing a MP3 disc

- 1 Insert a MP3 CD.
→ The disc content menu appears.

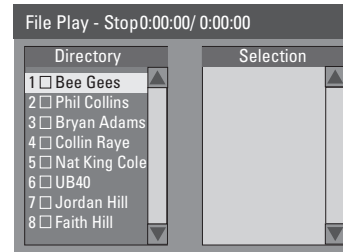

Note: It may require longer time for the DVD recorder to display the disc content menu on the TV due to the large number of songs/ pictures compiled into one disc.

- 2 Use ▲▼ keys to navigate within the menu and press **OK** to access the folder/ album.
- 3 Use ▲▼ keys to select the track/ file to play.
- To move up to the previous level, press **RETURN**.
- 4 To create a playlist, highlight the track/ file and press **SELECT**.
→ The selected tracks/ files will appear on the right screen.
→ To remove the track/ file from the playlist, press **CLEAR**.
- 5 To start playback, move the cursor to the right selection screen, press **PLAY ▶**.
- 6 During playback, you can press **◀◀ / ▶▶** to select the next/ previous track.
- 7 To stop playback, press **STOP ■**.

Helpful Hint:

– Only the first session of a multi-session CD will play back.

TIPS: Some discs cannot be played on this DVD recorder due to the configuration and characteristics of the disc, or due to the condition of recording and authoring software.

Playback (continued)

Playing a picture disc (or musical slide show)

You can display JPEG pictures in the selected roll automatically one after the other.

- 1 Insert a JPEG picture disc (CD, CD-R/RW, DVD±R/±RW).
→ The disc content menu appears.
- 2 Use ▲▼ keys to navigate within the menu and press **OK** to access the folder/album.
- 3 To create a playlist, highlight the track/file and press **SELECT**.
→ The selected tracks/ files will appear on the right screen.
→ To remove the track/ file from the playlist, press **CLEAR**.
- 4 You can select to playback from the original disc content or from the playlist, just use ◀▶ keys to move to the correct screen before selecting the track/ file for playback.

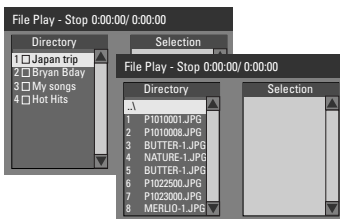

If the disc contained MP3 music and JPEG picture files, you can start a musical slide show playback,

- Select an MP3 file and press **OK** to start the playback, select a picture file in the menu and press **OK** to start the musical slide show playback.
- 5 During playback, you can press **T/C** on the remote control to access various settings for the slide show playback.

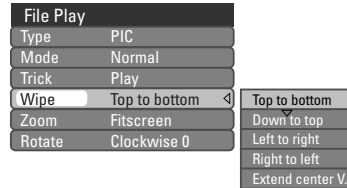

- 6 To stop playback, press **STOP** ■.

Playable JPEG picture disc

This DVD recorder can read JPEG pictures stored on a CD-ROM, Picture CD, or DVD.

File format:

- The file extension has to be '.JPG,' '.JPE' or '.JPEG.'
- It can only display DCF-standard still pictures or JPEG pictures e.g. TIFF. It cannot play back moving pictures, Motion JPEG, progressive JPEG and other formats, or pictures in formats other than JPEG, or pictures associated with sound.

TIPS: Some discs cannot be played on this DVD recorder due to the configuration and characteristics of the disc, or due to the condition of recording and authoring software.

Additional Playback Features

Changing to another title/ chapter/ track

When a disc contains more than one track, title or chapter, you can change to a different track, title or chapter as follows.

During playback,

- Press **▶▶** to go to the next title/ chapter/ track.
- Press **◀◀** to return to the start of the previous title/ chapter/ track.
OR
- Use the **numeric keypad 0-9** to input the title/ chapter/ track number.
OR
- Press **T/C** to enter the T/C menu and use **▲▼** keys to select { **Title** } or { **Chapter** } and use **numeric keypad 0-9** to input the title/ chapter/ track number.

Pausing playback and step play

- 1 During playback, press **⏸** to pause playback and display a still picture.
- 2 Press **⏸** again to move one frame forward.
- 3 To resume normal playback, press **▶**.

Searching forwards/ backwards

You can fast forward or fast reverse a disc at two, four, sixteen or thirty-two times the normal playback speed.

- 1 During playback, press **◀** (reverse) or **▶** (forward) to switch to the search function.
 - The search status bar appears. It displays the search speed (FREV x32, FREV x16, FREV x4, FREV x2, FFWD x2, FFWD x4, FFWD x16, FFWD x32)
 - The sound will be muted.
- 2 Press **◀** (reverse) or **▶** (forward) to cycle through the search speeds.
- 3 To resume normal playback, press **▶**.

TIPS: The operating features described here might not be possible for certain discs. Always refer to the instructions supplied with the discs.

Additional Playback Features (continued)

Using T/C options

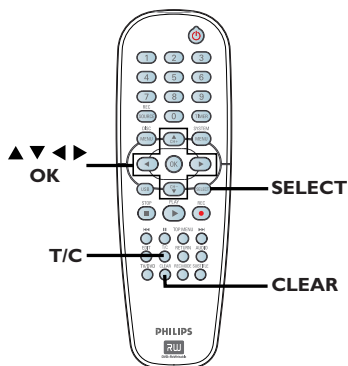

- 1 During playback, press **T/C** on the remote control.
→ The T/C menu appears on the TV.

DVD	
Mode	Normal
Trick mode	Play
Title	02/05
Chapter	01/22
Audio	01/02 - 0TH
Subtitle	Off
Angle	01/03
T- Time	00:22:03 - 00:27:24

- 2 Use **▲▼** keys to select the setting you want to adjust.
→ Instructions and explanation of the options are provided in the following pages.
- 3 To exit, press **T/C**.

Selecting various repeat/ shuffle functions

You can select various repeat play or random play mode during playback.

- 1 During disc playback, press **T/C** on the remote control.
→ The T/C menu appears.
- 2 Use **▲▼** keys to select { **Mode** } and press **OK**.
- 3 Use **▲▼** keys to select one of the repeat options.

{ Repeat A-B }

Select this to repeat the playback of a specific segment within a title/ chapter/ track. Press **OK** to mark the start and end of the segment you want to repeat.

{ Repeat Chapter }

Select this to repeat playback of the current chapter (DVD, DVD±R/±RW only).

{ Repeat Track/Title }

Select this to repeat playback of the current track/ title.

{ Repeat Directory }

Select this to repeat playback of the current folder/ directory (MP3, JPEG, picture disc only).

{ Repeat Disc }

Select this to repeat playback of the entire disc.

{ Shuffle }

Select this to randomly playback all the tracks within the disc (MP3 and audio CD only).

{ Normal }

Select this to cancel the repeat mode and return to normal playback.

- 4 To cancel repeat playback, press **STOP ■** or select { **Normal** } and press **OK**.

TIPS: The operating features described here might not be possible for certain discs. Always refer to the instructions supplied with the discs.

Additional Playback Features (continued)

Programming disc tracks

You can play the contents of the disc in the order you want by programming the tracks to be played.

- 1 Press **T/C** on the remote control.
→ The T/C menu appears.
- 2 Select { **Mode** } > { **Program** }.
→ The programme menu appears.

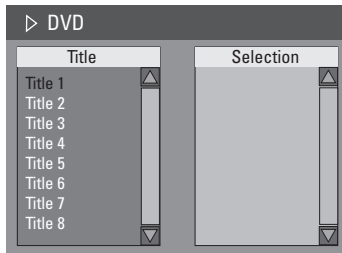

- 3 If the disc is recorded with Titles/ Folders/ Albums, press **OK** to access the tracks/ files/ chapters.
 - Pressing **OK** at the highlighted track/ file/ chapter will start playback.
 - Use **◀▶** keys to toggle between the left and right screen.

To programme your favourite track/ file/ chapter

- 4 Use **▲▼** keys to select the track/ file/ chapter to programme and press **SELECT** on the remote control.
→ The selected track/ file/ title will appear at the right screen.
→ The order on the right screen will be the order of programme playback.

To remove the programmed item from your selection

- 5 Press **▶** key to move to the right screen. Select the track/ file/ chapter and press **CLEAR** on the remote control.

To start programme play

- 6 Press **▶** key to move to the right screen and press **OK**.
→ Playback will start from the selected track/ file/ chapter according to the programmed sequence.

To exit programme play

- 7 Press **STOP** **■** to exit programme play.

Changing the audio soundtrack language

This operation works only on DVDs with multiple soundtrack language or VCDs with multiple audio channels.

This function can also be accessed via the **AUDIO** button on the remote control.

- 1 Press **T/C** on the remote control.
→ The T/C menu appears.
- 2 Use **▲▼** keys to select { **Audio** } and press **▶** to access its options.
- 3 Use **▲▼** keys to select the audio language and press **OK** to confirm.
→ The languages may be numbered or abbreviated, such as "En" for English.
→ If the language selected is not available on the disc, the disc's default setting for language will be used instead.

Helpful Hint:

– Some DVDs allow soundtrack language changes only via the DVD disc menu. To access the Disc Menu, press **DISC-MENU**.

TIPS: The operating features described here might not be possible for certain discs. Always refer to the instructions supplied with the discs.

Additional Playback Features (continued)

Changing subtitle language

This operation works only on DVDs with multiple subtitle languages, you can change the language you want while playing the DVD.

This function can be also accessed via the **SUBTITLE** button on the remote control.

- 1 Press **T/C** on the remote control.
→ The T/C menu appears.
- 2 Use **▲▼** keys to select { **Subtitle** } and press **▶** to enter the menu and find different available options.
- 3 Use **▲▼** keys to select the language and press **OK** to confirm.
→ The languages may be numbered or abbreviated, such as “En” for English.
→ If the language selected is not available on the disc, the disc’s default setting language will be used instead.

Helpful Hint:

– Some DVDs discs allow subtitle language changes only via the DVD disc menu. To access the disc menu, press **DISC-MENU**.

Switching camera angles

This option is only available with DVDs that contain sequences recorded from different camera angles. This allows you to view the picture from different angles.

This function can be also accessed via the **ANGLE** button on the remote control.

- 1 Press **T/C** on the remote control.
→ The T/C menu appears.
- 2 Use **▲▼** keys to select { **Angle** } and press **▶** to enter the menu.
→ The camera angles available for selection appears.
- 3 Use **▲▼** keys to select the camera angle you want to switch to, then press **OK** to confirm.

TIPS: The operating features described here might not be possible for certain discs. Always refer to the instructions supplied with the discs.

Time search

This option allows you to skip to a specific point in the current disc.

- 1 Press **T/C** on the remote control.
→ The T/C menu appears.
- 2 Use **▲▼** keys to select { **T-Time** } and use the **numeric keypad (0-9)** to enter the time required.
→ Playback skips to the selected time.

DVD System Menu Options

Accessing System Menu - General

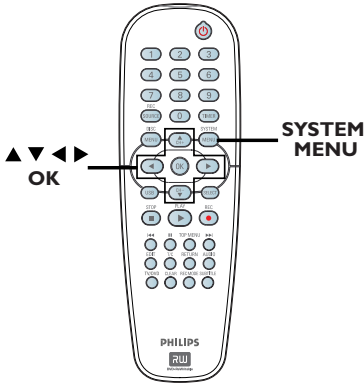

- 1 Press **SYSTEM-MENU** on the remote control.
→ The system menu appears on the TV.
- 2 Use ▲▼ keys to select  { **System Menu - General** } and press ► to access its options.

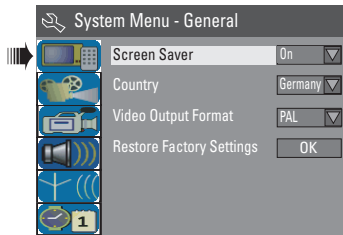

- 3 Use ▲▼ keys to select the setting you wish to change and press **OK** to confirm.
→ Instructions and explanation of the options are provided in the following pages.
- 4 To exit, press **SYSTEM-MENU**.

Screen Saver

A screen saver prevents damage to the TV screen by avoiding exposure to a static image for too long.

- 1 In 'System Menu-General', use ▲▼ keys to highlight { **Screen Saver** } and press **OK**.

{ On }

Select this if you wish to turn off the TV screen, after playback had been stopped or paused for more than 15 minutes.

{ Off }

Select this to disable the screen saver.

- 2 Use ▲▼ keys to select a setting and press **OK** to confirm.

Country

Select the country of your area for auto channel tuning.

- 1 In 'System Menu - General', use ▲▼ keys to select { **Country** } and press **OK**.
- 2 Use ▲▼ keys to select the country of your residence and press **OK** to confirm.

TIPS: The underlined option is the factory default setting.
Press ◀ to go back to previous menu item. Press **SYSTEM MENU** to exit the menu item.

DVD System Menu Options (continued)

Video Output Format

The colour system of the DVD system, DVD and TV should match. Only then will it be possible to play a DVD on this system. Before changing the TV system, determine the colour system of your TV.

- 1 In 'System Menu-General', use ▲▼ keys to select { **Video Output Format** } and press **OK**.

{ **NTSC** }

Select this if the connected TV has the NTSC colour system. It will change the video signal of a PAL disc and output it to NTSC format.

{ **PAL** }

Select this if the connected TV has the PAL colour system. It will change the video signal of an NTSC disc and output it to PAL format.

- 2 Use ▲▼ keys to select a setting and press **OK** to confirm.

Helpful Hint:

– If a blank/ distorted TV screen appears, wait for 15 seconds for the auto recovery.

Restore Factory settings

This will restore all the settings of this DVD Recorder, except for the PIN code.

Restore Factory settings can only be changed when there is no disc in the disc tray.

- 1 In 'System Menu-General', use ▲▼ keys to select { **Restore Factory Settings** } and press **OK**.

→ A warning message will appear.

- 2 Select in the menu to proceed or to abort, then press **OK** to confirm.

TIPS: The underlined option is the factory default setting.

Press ◀ to go back to previous menu item. Press **SYSTEM MENU** to exit the menu item.

DVD System Menu Options (continued)

Accessing System Menu - Playback

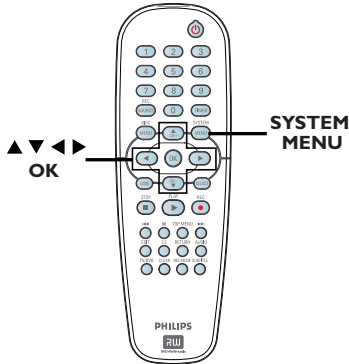

Playback settings can only be changed when there is no disc in the disc tray.

- 1 Press **SYSTEM-MENU** on the remote control.
→ The system menu appears on the TV.
- 2 Use **▲▼** keys to select { **System Menu - Playback** } and press **▶** to access its options.

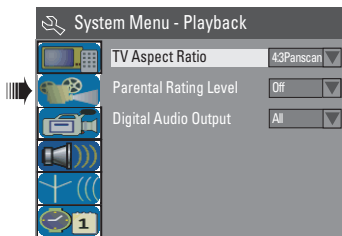

- 3 Use **▲▼** keys to select the setting you wish to change and press **OK** to confirm.
→ Instructions and explanation of the options are provided in the following pages.
- 4 To exit, press **SYSTEM-MENU**.

TV Aspect Ratio

Set the aspect ratio of the DVD recorder according to the TV type you have connected. The format you select must be available on the disc. If it is not, the setting for TV display will not affect the picture during playback.

- 1 In 'System Menu-Playback', use **▲▼** keys to select { **TV Aspect Ratio** } and press **OK**.

{ 16:9 }

Select this for wide screen TV (frame ratio 16:9).



{ 4:3 Letterbox }

Select this for a 'wide screen' display with black bands on the upper and lower portions of the TV screen.



{ 4:3 panscan }

Select this for a full-height picture with both side trimmed.



- 2 Press **▲▼** to select a setting and press **OK** to confirm.

TIPS: The underlined option is the factory default setting.
Press **◀** to go back to previous menu item. Press **SYSTEM MENU** to exit the menu item.

DVD System Menu Options (continued)

Parental rating level

Some DVDs may have a parental level assigned to the complete disc or to certain scenes on the disc. This feature allows you to set a playback limitation level. The rating levels are from 1 to 8 and are country dependent. You can prohibit the playing of certain discs that are not suitable for your children, or have certain discs played with alternative scenes.

- 1 In 'System Menu-Playback', use ▲▼ keys to select { **Parental Rating Level** } and press **OK**.
→ You will be prompted to enter your four-digit pin code.

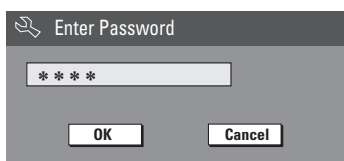

- 2 Use the **numeric keypad 0-9** to enter your four-digit pin code.
→ When doing this for the first time, enter the default password '3308'.
→ The set rating level menu appears.



- 3 If you forgot your four-digit pin code, the default password is 3308.
- 3 Use ▲▼ keys to select the top field and press **OK** to confirm.
- 4 Use ▲▼ keys to select the desired parental level, then move to in the menu and press **OK** on the remote control to confirm.
→ To disable parental controls and allow all discs to play, select { **Off** }.

Rating explanations

- { **Off** }
– Parental Control is not active.
 - { **1. Kid Safe** } ~ { **2. G** }
– Childsafe; acceptable for viewers of all ages.
 - { **3. PG** }
– Parental Guidance suggested.
 - { **4. PG 13** }
– Unsuitable for children under age 13.
 - { **5. PG R** } ~ { **6. R** }
– Restricted; recommended that parents restrict children under 17 from viewing or allow to view only when supervised by a parent or adult guardian.
 - { **7. NC 17** }
– No children under age 17; not recommended viewing for children under age 17.
 - { **8. Adult** }
– Mature material; should be viewed only by adults due to graphic sexual material, violence or language.
- DVDs that are rated higher than the level you selected will not play unless you enter your four-digit pin code.

Helpful hints:

- This feature will not limit viewing if the disc manufacturer did not code the disc.
- VCD, SVCD, CD has no level indication, so parental control has no effect on these type of discs. This also applies to most illegal DVDs.
- Some DVDs are not coded with a rating though the movie rating may be printed on the Disc cover. The rating level feature does not prohibit play of such Discs.

TIPS: The underlined option is the factory default setting.

Press ◀ to go back to previous menu item. Press **SYSTEM MENU** to exit the menu item.

DVD System Menu Options (continued)

Setting or changing the password

You need to enter your four-digit password to play a prohibited disc or if prompted for a pin code.

- In 'System Menu-Playback', use ▲▼ keys to select { **Parental Rating Level** } and press **OK**.
→ You will be prompted to enter your four-digit pin code.

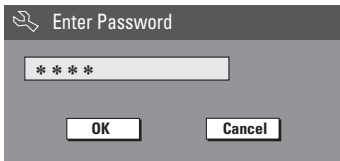

- Use the **numeric keypad 0-9** to enter your four-digit pin code and select **OK** in the menu and press **OK** on the remote control to confirm.
→ The set rating level menu appears.

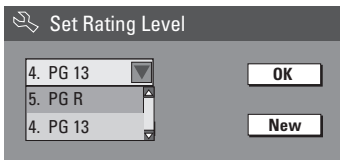

- Move to **New** in the menu and press **OK** to access new password menu.

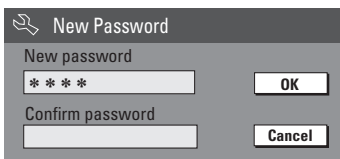

- Use the **numeric keypad 0-9** to enter your new four-digit pin code, then press ▼ to select the next entry field and enter the same pin code a second time.
- Move to **OK** in the menu and press **OK** to confirm.
→ To abort the change, select **CANCEL** and press **OK**.

TIPS: The underlined option is the factory default setting.
Press ◀ to go back to previous menu item. Press **SYSTEM MENU** to exit the menu item.

Digital Audio Output

After connecting the DVD recorder to your TV and other devices, you may need to change the digital output setting. Adjust the Digital Output only if you have used the DVD recorder's coaxial socket.

- In 'System Menu Playback', use ▲▼ keys to select { **Digital Audio Output** } and press **OK**.

{ ALL }

Select this if you have used the COAXIAL jack to connect the DVD recorder to a stereo receiver that has a built in Multi-Channel decoder.

{ LPCM }

Select this if the connected audio equipment is not capable of decoding multichannel audio Dolby Digital and MPEG-2 multi - channel signals are converted to PCM (Pulse Code Modulation).

- Use ▲▼ keys to select a setting and press **OK** to confirm.

DVD System Menu Options (continued)

English

Accessing System Menu - Record

See pages 27~29 on "Recording settings".

Accessing System Menu - Language

See page 25 on "Setting the language".

Accessing System Menu - Channel Setup

See pages 23~25 on "TV channel programming".

Accessing System Menu - Clock

Date and Time

See page 26 on "Setting the time & date".

TIPS: The underlined option is the factory default setting.
Press ◀ to go back to previous menu item. Press **SYSTEM MENU** to exit the menu item.

Troubleshooting

WARNING

Under no circumstances should you try to repair the system yourself, as this will invalidate the warranty. Do not open the system as there is a risk of electric shock.

If a fault occurs, first check the points listed below before taking the system for repair. If you are unable to remedy a problem by following these hints, consult your dealer or Philips for help.

Problem	Solution
No power.	<ul style="list-style-type: none"> – Press STANDBY-ON on the front of the DVD recorder to switch on the system. – Make sure the AC outlet has power.
Remote control does not work.	<ul style="list-style-type: none"> – Aim the remote control directly at the sensor on the front of the DVD recorder (not towards TV). – Remove any obstacles between DVD recorder and the remote control. Aim the remote control towards the recorder from different angles and/or distances. – Batteries are weak, replace the batteries. – Press REC SOURCE on the remote control to select an input source.
Disc does not play.	<ul style="list-style-type: none"> – Insert the disc with the label facing up. – Wrong region code. The DVD must be coded for ALL regions or Region 2 in order to play on this DVD recorder. – There is no recording on the disc or wrong disc type. Read chapter "Playback - Playable discs" for details. – Make sure the disc is not scratched or warped. Clean the disc or replace a new one. – Check if the disc is defective by trying another disc.
No sound.	<ul style="list-style-type: none"> – Check the audio connections, the red and white sockets. Read chapters "Getting Started - Connecting the audio cables" for details. – Set the Digital output correctly, based on the equipment you connected to the DVD recorder. Read chapter "Accessing System Menu - Digital Audio Output" for details.
Distorted sound coming from a connected hi-fi amplifier.	<ul style="list-style-type: none"> – Do not connect any cables from the DVD recorder to the 'Phono' input of your amplifier. – Do not connect the DVD recorder's Coaxial DIGITAL AUDIO OUT socket to an analogue socket (red/white) on the connecting devices.
A TV channel installed during the DVD recorder's automatic TV channel search is fuzzy or distorted.	<ul style="list-style-type: none"> – Check the video connection between the DVD recorder and the TV. – You can further fine-tune the signal of the TV channel. Read chapter on "TV channel programming – Modifying channel information." – Press CH +/- to search for the same TV channel which may have a clearer picture.
Disc cannot be edited.	<ul style="list-style-type: none"> – The recordings were made on another DVD recorder and hence cannot be edited.



Troubleshooting (continued)

Problem	Solution
No picture.	<ul style="list-style-type: none"> – Switch on your TV and set to the correct Video In channel. Change the TV channel until you see the DVD screen. Read chapter “Getting Started - Finding the viewing channel” for details. – Check the video connection between the DVD recorder and the TV.
The picture is distorted or black and white during playback.	<ul style="list-style-type: none"> – The disc does not match with the TV colour system standard (PAL/ NTSC). – The disc is dirty, clean the disc. – Do not tie the cables of the connected equipment together. – Sometimes a small amount of picture distortion may appear. This is not a malfunction. – For better video quality, select 1 hour or 2 hour recording mode. Read chapter “Recording - Recording settings” for details. – The recording can be made in colour only when the TV channels or the connected additional device sends a colour signal. In some situations, programmes that are broadcast in black and white cannot be recorded.
Recordings are not occurring as scheduled. New recordings cannot be made.	<ul style="list-style-type: none"> – The TV channel you want to record is not stored or you selected the wrong programme number. Check TV channels stored. – If you adjust the clock after you set a timer recording, you have to reset the timer recording. – If the DVD recorder cannot read the disc, you cannot record. – You cannot use the DVD recorder to duplicate copyrighted materials (DVDs or videotapes) onto a DVD±R/±RW. – A finalised DVD±R has been inserted. Change disc.
No TV signal received from the DVD recorder.	<ul style="list-style-type: none"> – Install the TV channel. Read chapter “Step 4 : TV channel programming” for details.
A DVD±R/±RW recorded on this DVD recorder does not play on a DVD player.	<ul style="list-style-type: none"> – If a recording is too short, it is possible that a DVD player cannot detect it. Please observe the following ‘minimum recording times’. Recording mode : {1 hour} – 5 minutes, {2 hours} – 10 minutes, {4 hours} – 20 minutes, {6 hours} – 30 minutes. – You have to finalise the DVD±R. Refer to chapter “Playing your recordings (DVD±R) on other DVD players” for details.
Picture is fuzzy and brightness varies when copying DVD Video discs or pre-recorded video cassettes.	<ul style="list-style-type: none"> – This happens if you try to copy DVDs or video cassettes that have been copy-protected. Even though the picture on the TV is fine, but the recording on a DVD±R/±RW is faulty. This interference is unavoidable with copy-protected DVDs or video cassettes. – The DVD±R/±RW has recording lifetime, please change a new disc for recording.
A TV channel installed during the DVD recorder’s automatic TV channel search is fuzzy or distorted.	<ul style="list-style-type: none"> – Make sure you have selected the correct TV colour system standard (PAL/NTSC)



Specifications

Picture/Display

- Aspect ratio: 4:3, 16:9
- D/A converter: 10 bit, 54 MHz
- A/D converter: 10 bit, 54 MHz

Sound

- D/A converter: 24 bit, 96 kHz
- A/D converter: 24 bit, 96 kHz
- Signal to noise ratio: 106
- Crosstalk (1kHz): 105 dB
- Dynamic Range (1kHz): 90 dB

Video Recording

- Recording system: PAL
- Compression formats: MPEG2
- Recording modes: 1 hour (high quality), 2 hours (DVD quality), 4 hours (VHS quality), 6 hours (VHS quality)
- Audio compression: Dolby Digital

Video Playback

- Disc playback media: CD, CD-R/-RW, DVD, DVD-Video, DVD±R/±RW, SVCD, Video CD
- Compression formats: MPEG2, MPEG1
- Video disc playback system: NTSC, PAL

Audio Playback

- Disc playback media: CD, CD-R/-RW, MP3-CD, MP3-DVD
- Compression formats: Dolby Digital, DTS, MP3, MPEG2 Multichannel, PCM
- MP3 bit rates: 32–256 kbps and VBR

Still Picture Playback

- Disc formats: DVD±R/±RW, Picture CD
- Picture compression formats: JPEG
- Picture enhancement: Rotate

Storage Media

- Recording media: DVD±R, DVD±RW

Tuner/Reception/Transmission

- TV system: PAL
- Aerial Input: 75 Ohm coaxial (IEC75)

Connectivity

Rear Connections:

- Scart (2x)
- S- Video Out
- Video (CVBS) Out
- Audio left/right Out
- Digital audio out (coaxial)
- RF antenna in
- RF TV out
- Mains

Front Connections:

- S-Video In
- Video In
- Audio left/right In

Convenience

- Programming/Timer Enhancements: Daily/Weekly, Repeat Programme, Manual Timer, One Touch Recording, VIDEO Plus+®
- Programmable events: 8

Power

- Power supply: 220 – 230 V; 50 Hz
- Consumption: 27 W (typical)
- Standby power consumption: < 3W

Cabinet

- Dimensions (wxhxd) : 435 x 65 x 285 mm
- Net Weight : 3.85 kg

This set is designed without any fan or ventilation. Heat dissipation is via the metal casing. Thus it is **NORMAL** that the set could be quite warm when switched on.

Reminder : Do Not place anything above or under the set obstructing its heat dissipation.

Analogue: Sound that has not been turned into numbers. Analogue sound varies, while digital sound has specific numerical values. These sockets send audio through two channels, the left and right.

Aspect ratio: The ratio of vertical and horizontal sizes of a displayed image. The horizontal vs. vertical ratio of conventional TVs. is 4:3, and that of wide-screens is 16:9.

AUDIO OUT Sockets: Red and white sockets on the back of the system that send audio to another system (TV, Stereo, etc).

Chapter: Sections of a picture or a music piece on a DVD that are smaller than titles. A title is composed of several chapters. Each chapter is assigned a chapter number enabling you to locate the chapter you want.

Component Video Out Sockets: Sockets on the back of the DVD System that send high-quality video to a TV that has Component Video In sockets (R/G/B, Y/Pb/Pr, etc).

Digital: Sound that has been converted into numerical values. Digital sound is available when you use the DIGITAL AUDIO OUT COAXIAL. These sockets send audio through multiple channels, instead of just two channels as analogue does.

Disc menu: A screen display prepared for allowing selection of images, sounds, subtitles, multi-angles, etc recorded on a DVD.

Dolby Digital: A surround sound system developed by Dolby Laboratories containing up to six channels of digital audio (front left and right, surround left and right, centre and subwoofer).

DTS: Digital Theatre Systems. This is a surround sound system, but it is different from Dolby Digital. The formats were developed by different companies.

Index Picture Screen: A screen that gives an overview of a DVD±RW or DVD±R. An Index Picture represents each recording.

JPEG: A very common digital still picture format. A still-picture data compression system proposed by the Joint Photographic Expert Group, which features small decrease in image quality in spite of its high compression ratio.

MP3: A file format with a sound data compression system. "MP3" is the abbreviation of Motion Picture Experts Group 1 (or MPEG-1) Audio Layer 3. By using the MP3 format, one CD-R or CD-RW can contain about 10 times more data than a regular CD.

MPEG: Motion Picture Experts Group. A collection of compression systems for digital audio and video.

Multichannel: DVDs are formatted to have each sound track constitute one sound field. Multichannel refers to a structure of sound tracks having three or more channels.

PBC: Playback Control. Refers to the signal recorded on video CDs or SVCDs for controlling playback. By using menu screens recorded on a Video CD or SVCD that supports PBC, you can enjoy interactive playback and searching.

PCM: Pulse Code Modulation. A digital audio encoding system.

Parental control: Limits disc play according to the age of the users or the limitation level in each country. The limitation varies from disc to disc; when it is activated, playback will be prohibited if the software's level is higher than the user-set level.

Region code: A system allowing discs to be played only in the region designated. This unit will only play discs that have compatible region codes. You can find the region code of your unit by looking on the product label. Some discs are compatible with more than one region (or ALL regions).

S-Video: Produces a clear picture by sending separate signals for the luminance and the color. You can use S-Video only if your TV has an S-Video In socket.

Surround: A system for creating realistic threedimensional sound fields full of realism by arranging multiple speakers around the listener.

Title: The longest section of a movie or music feature on DVD. Each title is assigned a title number, enabling you to locate the title you want.

VIDEO OUT socket: Yellow socket on the back of the DVD system that sends the DVD picture video to a TV.

TV System Guide

English

COUNTRY	VHF	UHF	DVD REGIONS
AFGHANISTAN	PAL/SECAM B		5
ALBANIA	PAL B	PAL G	2
ALGERIA	PAL B	PAL G	5
ANGOLA	PAL I		5
ARGENTINA	PAL N	PAL N	4
AUSTRALIA	PAL B	PAL H	4
AUSTRIA	PAL B	PAL G	2
AZORES	PAL B		
BAHAMAS	NTSC M		4
BAHRAIN	PAL B	PAL G	2
BANGLADESH	PAL B		5
BARBADOS	NTSC M		4
BELGIUM	PAL B	PAL H	2
BERMUDA	NTSC M		
BOLIVIA	NTSC M	NTSC M	4
BOTSWANA	PAL I		5
BRAZIL	PAL M	PAL M	4
BRUNEI	PAL B	PAL B	
BULGARIA	SECAM D	SECAM K	2
BURKINA FASO	SECAM K1		5
BURMA	NTSC M		
BURUNDI	SECAM K1		5
CAMBODIA	NTSC M		3
CAMEROON	PAL B	PAL G	5
CANADA	NTSC M	NTSC M	1
CANARY ISLANDS	PAL B		2
CHAD	SECAM K1		5
CHILE	NTSC M	NTSC M	4
CHINA	PAL D		6
COLOMBIA	NTSC M	NTSC M	4
COSTA RICA	NTSC M	NTSC M	4
CROATIA	PAL B	PAL G	2
CUBA	NTSC M	NTSC M	4
CYPRUS	PAL B	PAL G	
CZECH REPUBLIC	PAL D	PAL K	2
DAHOMEY	SECAM K1		
DENMARK	PAL B	PAL G	2
DJIBOUTI	SECAM B	SECAM G	5
DOMINICAN REP	NTSC M	NTSC M	4
ECUADOR	NTSC M	NTSC M	4
EGYPT	SECAM B/PAL B	SECAM G/PAL G	2
EL SALVADOR	NTSC M	NTSC M	4
EQUAT. GUINEA	PAL B		5
ESTONIA	PAL B (was SECAM)	PAL D	5
ETHIOPIA	PAL B	PAL G	5
FIJI	PAL B		
FINLAND	PAL B	PAL G	2
FRANCE	SECAM L	SECAM L	2
FRENCH POLYNESIA	SECAM K1		
GABON	SECAM K1		5
GAMBIA	PAL I		5
GERMANY	PAL B	PAL G	2
GHANA	PAL B	PAL G	5
GIBRALTAR	PAL B	PAL H	2
GREECE	PAL B (was SECAM)	PAL G	2
GREENLAND	NTSC/PAL B		2
GUADELOUPE	SECAM K1		
GUAM	NTSC M		1
GUATEMALA	NTSC M	NTSC M	4
GUINEA	PAL K		5
GUYANA (FRENCH)	SECAM K1		4
HONDURAS	NTSC M	NTSC M	4

TV System Guide (continued)

COUNTRY	VHF	UHF	DVD REGIONS
LIBYA	SECAM B	SECAM G	5
LITHUANIA	PAL D (was SECAM)	PAL K	5
LUXEMBOURG	PAL B/SECAM L	PAL G/SEC L	2
MADAGASCAR	SECAM K1		5
MADEIRA	PAL B		
MALAGASY	SECAM K1		
MALAWI	PAL B	PAL G	5
MALAYSIA	PAL B		3
MALI	SECAM K1		5
MALTA	PAL B	PAL H	2
MARTINIQUE	SECAM K1		
MAURITANIA	SECAM B		5
MAURITIUS	SECAM B		5
MEXICO	NTSC M	NTSC M	4
MONACO	SECAM L		2
MONGOLIA	SECAM D		5
MOROCCO	SECAM B		5
MOZAMBIQUE	PAL B		5
NAMIBIA	PAL I		5
NEPAL	PAL B		
NETHERLANDS	PAL B	PAL G	2
NETH. ANTILLES	NTSC M	NTSC M	
NEW CALEDONIA	SECAM K1		
NEW GUINEA	PAL B	PAL G	4
NEW ZEALAND	PAL B	PAL G	4
NICARAGUA	NTSC M	NTSC M	4
NIGER	SECAM K1		5
NIGERIA	PAL B	PAL G	5
NORWAY	PAL B	PAL G	2
OMAN	PAL B	PAL G	2
PAKISTAN	PAL B		5
PANAMA	NTSC M	NTSC M	4
PARAGUAY	PAL N	PAL N	4
PERU	NTSC M	NTSC M	4
PHILIPPINES	NTSC M	NTSC M	3
POLAND	PAL D	PAL K	2
PORTUGAL	PAL B	PAL G	2
PUERTO RICO	NTSC M	NTSC M	1
QATAR	PAL B		2
REUNION	SECAM K1		
RUMANIA	PAL D	PAL K	2
RUSSIA	SECAM D	SECAM K	5
RWANDA	SECAM K1		5
SABAH/SAWARA	PAL B		
ST. KITTS	NTSC M	NTSC M	
SAMOA (US)	NTSC M		1
SAUDI ARABIA	SECAM-B/PAL-B	SECAM G	2
SENEGAL	PAL		5
SEYCHELLES	PAL B	PAL G	5
SIERRA LEONE	PAL B	PAL G	5
SINGAPORE	PAL B	PAL G	
SLOVAK REPUBLIC	PAL	PAL	2
SOMALIA	PAL B	PAL G	5
SOUTH AFRICA	PAL I	PAL I	2
SPAIN	PAL B	PAL G	2
SRI LANKA	PAL B		5
SUDAN	PAL B	PAL G	5
SURINAM	NTSC M	NTSC M	4
SWAZILAND	PAL B	PAL G	
SWEDEN	PAL B	PAL G	2
SWITZERLAND	PAL B	PAL G	2
SYRIA	SECAM B		2

English

English

Meet Philips at the Internet
<http://www.philips.com/support>

 Be responsible
Respect copyrights



DVDR3305



3139 246 16862



SgpJP-0544/05-1